

# MONROC

USER MANUAL

Original Instructions



CONTENT .....	2
SYMBOL DESCRIPTION .....	4
Hazard intensity levels.....	4
GENERAL.....	5
Introduction .....	5
General instructions.....	5
Warnings.....	5
Precautions.....	6
Intended use.....	6
TECHNICAL SPECIFICATIONS.....	7
MONROC 1GR .....	7
Accessories.....	7
MONROC 2GR .....	8
Accessories.....	8
OVERVIEW OF COMPONENTS.....	9
MONROC 1GR .....	9
DIMENSION SKETCH.....	10
MONROC Control 2GR .....	10
MONROC Pulsar 2GR.....	10
DIMENSION SKETCH.....	11
TRANSPORT .....	12
INSTALLATION.....	12
Packaging.....	12
Delivery inspection.....	12
Positioning.....	12
Electrical installation.....	13
Connection types.....	13
Water connection .....	14
Pressure and temperature.....	14
Starting the machine.....	14
The portafilter set .....	15
Inserting the portafilter in the group .....	15
OPERATION.....	16
Espresso brewing.....	16
Steaming and frothing milk .....	17
Hot water dispensing.....	18
CLEANING AND MAINTENANCE.....	19
Coffee machine cleaning.....	19
Daily cleaning.....	19

Weekly cleaning .....	19
Cleaning and descaling the brewing group and portafilter .....	20
Cleaning the gasket and shower plate .....	21
STORAGE AND DISPOSAL OF MACHINE .....	22
Additional handling of the machine .....	22
How to store the machine .....	22
Disposal of machine .....	22
PROGRAMMING .....	23
Buttons functions .....	23
Additional button functions .....	23
Programming the coffee dosage .....	24
TROUBLESHOOTING .....	25

## Hazard intensity levels

There are four different levels of notification intensity within this manual, as identified by the signal words DANGER, WARNING, IMPORTANT, and NOTE. The level of risk and importance of the notification is determined by the following definitions. Always observe the warnings to ensure safety and prevent potential injury and product damage.



*Important:*

Alerts against unsafe practices. Observe *Important* notifications to ensure food safety, prevent possible minor personal injury, or damage to the machine.



**WARNING:**

Indicates a potentially hazardous situation which, if the **WARNING** is ignored, could result in serious injury or even death.



**DANGER:**

**INDICATES A IMMINENTLY HAZARDOUS SITUATION WHICH, IF NOT AVOIDED, WILL LIKELY RESULT IN SERIOUS INJURY AND EVEN DEATH.**



*Note:*

Gives additional information which may be helpful during the operation, routine maintenance, and cleaning of the machine.

## Introduction

Thank you for choosing a MONROC espresso machine.

We hope you enjoy it !

- Read this user manual carefully before starting to use the machine.
- This manual contains important instructions regarding safe intended use of the machine.
- Do not discard this manual, it will be useful for future reference. If damaged or lost, request a copy from the manufacturer.

## General instructions

- Machine installation and certain maintenance operations should only be performed by qualified service personnel.
- All safety instructions and warnings contained in this manual should be observed at all times to ensure safe installation, use, and maintenance.
- Do not attempt to remove covers or safety shields to access the interior of this machine or make repairs. Repairs should be made by an authorised technician or service centre.
- Owners are liable for ensuring that users have been properly trained to operate the machine and understand the potential risks involved.
- The owner or installer will be liable for all non-authorized modification of the machine.
- Non-authorized alteration or modification of the machine will immediately void the manufacturer's warranty.
- This manual references the machine at the time of sale. The commercial availability of subsequent versions including modifications, upgrades or adaptations does not oblige the manufacturer to apply any changes to this machine, nor is it obliged to update the documentation supplied.
- The manufacturer reserves the right to withdraw currently available manuals whenever deemed appropriate and reasonable.
- Periodically, some updates and changes may be required for this machine. In this event, a technician will be responsible for ensuring the change is made in accord with manufacturer's specifications.

## Warnings

**Note:** The manufacturer is not liable for damage to persons or property resulting from failure to follow the instructions and warnings listed below when installing and using this machine.

- Install the machine in a horizontal position and away from heat sources and flammable objects.
- This machine should only be installed on a water-resistant work surface that is capable of adequately supporting the machine's weight.
- Place the machine in a location accessible only to personnel trained to operate it.
- Keep all hazardous packaging materials, such as plastic bags, styrofoam, and staples, out of reach of children.
- Plug the machine into a properly installed, earth grounded electrical outlet with line voltage that matches the specifications for the machine.
- Ensure that the power supply voltage does not fluctuate by more than 6%.
- Position the power cable so that users cannot trip over it. Keep the power cable away from sharp edges and heat sources.
- Children should never be allowed to play with the machine.
- This appliance is not suitable for installation in an area where a pressure washer may be used.
- Do not use the machine outdoors, where it would be exposed to severe weather or extreme temperatures.
- If the power cable is damaged, it may only be replaced by the manufacturer or its approved service technician.
- Do not remove or disable any of the mechanical, electrical, or thermal protection safety equipment.

- In case of emergency, (e.g., the machine catches fire or becomes unusually hot or noisy), disconnect the power immediately and turn off the water supply.
- If the machine is not going to be used for an extended period of time, disconnect the power. When disconnecting the power, pull the plug rather than the cable.
- When packed for storage, store the machine in a dry place with an ambient temperature above 5°C. Boxes may be stacked up to three units high of the same model. Do not place other heavy items on top of the box.
- If the machine is likely to be exposed to temperatures below 0 °C during handling and transport, make sure that service personnel empty the boiler and water system. (The machine's boiler and water system is empty when delivered from the factory.)
- To ensure fault-free machine operation, only use manufacturer-approved replacement parts and accessories.

## Precautions

- Before performing maintenance and/or moving the machine, disconnect the machine from the power supply and wait for it to cool down.
- Do not place any liquids on the machine.
- This appliance must not be cleaned with a pressure washer.
- Never immerse the machine, plug or power cable in water, as there is a risk of electric shock.
- Do not touch the machine's hot surfaces or dispensing equipment.
- Do not touch the machine if your hands or feet are wet.
- Do not operate the machine if any part except the dispensing equipment is wet.
- Place the machine out of reach of children.
- This appliance can be used by children from age 8 and above and persons with reduced physical, sensory, or mental capabilities or lack of experience and knowledge if they have been given supervision or instruction concerning use of the appliance in a safe way and understand the hazards involved.
- Children shall not play with the appliance.
- Cleaning and user maintenance shall not be made by children without supervision.
- Do not use the machine if the power cable or plug is damaged, or the machine has been dropped. Contact a service technician for repairs or to ensure that it is safe for use.
- Do not block the vents with rags or other objects.
- Do not insert foreign objects into the vents.
- Check the drain regularly to make sure that waste water is emptying properly.

## Intended use

- The coffee machine has been designed and manufactured to make espresso coffee and other hot drinks (e.g., steaming and frothing milk). Do not use it for any other purpose.
- The machine is intended to be used by trained personnel for preparing foodstuffs.
- This machine is not intended for use in industrial kitchens, domestic kitchens, or similar locations.
- The manufacturer will not be held liable for damage to persons or property due to incorrect, improper or negligent use by nonprofessional personnel.
- To ensure optimal performance, install the machine in a location where these parameters will not be exceeded:
  - Maximum permissible inlet water pressure: 600 KPa (6 Bar)
  - Minimum permissible inlet water pressure: 200 KPa (2 Bar)
  - Maximum inlet water temperature: 40°C
  - Ambient temperature is between +10 °C (min.) and +40 °C (max.).

## MONROC IGR

SPECIFICATIONS	MODEL	
	MINI IGR CONTROL	MINI IGR PULSER
Steam wand	1 unit	
Hot water outlet	1 unit	
Temperature control	Pressure switch	
Dispensing system for tall cups	Optional	
Height, width, depth (mm)	430, 460, 530	430, 460, 530
Boiler volume (L)	6 (L)	
Power supply	230V 1N~ 2770 W 50/60 Hz	230V 1N~ 2780 W 50/60 Hz
Water connection	Female 3/8" thread	
Machine weight (kg)	35.45	
Steam boiler operating pressure	Between 0.8 and 1.2 bar	
Ambient noise	< 70 db	

### Accessories

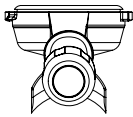
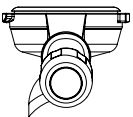
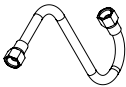
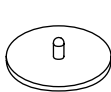
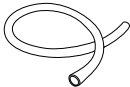
MODEL	2-spout portafilter	1-spout portafilter	55cm inlet hose	Cleaning Membrane	Drainage tube (150cm)
					
<b>MINI IGR</b>	1 unit	1 unit	1 unit	1 unit	1 unit
<b>MINI 2GR</b>	1 unit	1 unit	1 unit	1 unit	1 unit

## MONROC 2GR

SPECIFICATIONS	MODEL	
	PULSER 2GR	CONTROL 2GR
Machine model, Standard	-	EBEE-D32B-12AI 220-240V IN~ 3350W
Machine model, Take Away	-	EBEE-D32B-22AI 220-240V IN~ 3350W
Steam wand	1 unit	
Hot water outlet	1 unit	
Temperature control	Pressure switch	
Dispensing system for tall cups	Optional	
Height, width, depth (mm)	430, 650, 530	
Boiler volume (L)	11.5(L)	
Power supply	220-240V IN~ 3350W 50/60Hz	
Water connection	Female 3/8" thread	
Machine weight (kg)	45.20	
Steam boiler operating pressure	Between 0.8 and 1.2 bar	
Ambient noise	< 70 db	

### Accessories

MODEL	2-spout portafilter	1-spout portafilter	55cm inlet hose	Cleaning Membrane	Drainage tube (150cm)
<b>2GR</b>	2 units	1 unit	1 unit	1 unit	1 unit



Front view of the machine

MONROC IGR

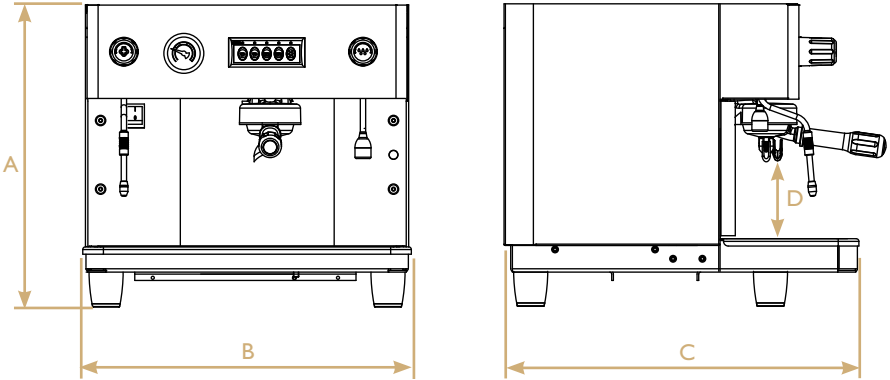

Model	A	B	C	D
MONROC IGr	430 mm	630 mm	530 mm	124 mm

MONROC Control 2GR

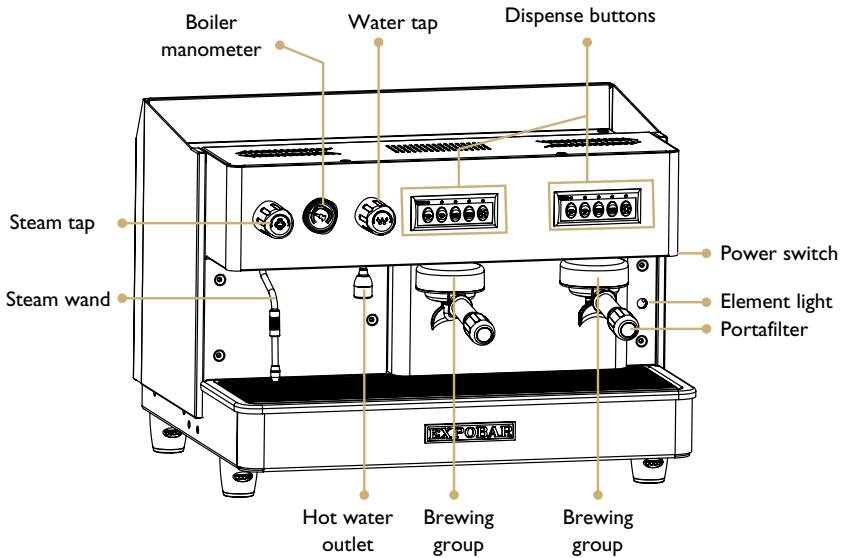

MONROC Pulser 2GR

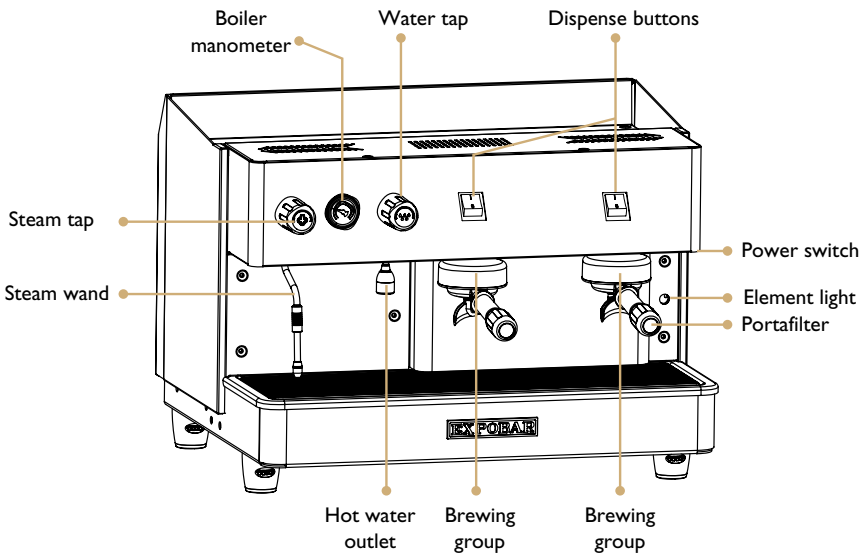

MONROC 2GR

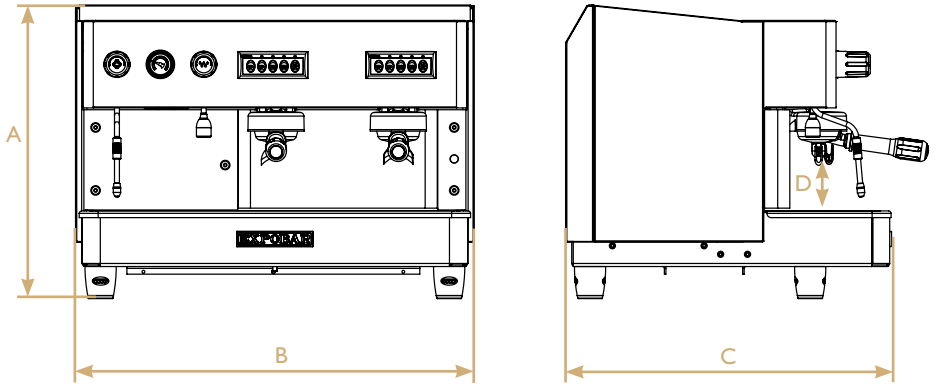

Model	A	B	C	D(Min)	D(Max)
MONROC control 2Gr	480 mm	660 mm	540 mm	74 mm	124 mm
MONROC pulser 2Gr	480 mm	660 mm	540 mm	74 mm	124 mm

## Packaging

- The machine is shipped in a custom-designed carton which utilizes model-specific polystyrene cushions to protect it from damage.
- The machine's carton features standardized handling symbols to explain proper shipping and storage methods.
- The machine must remain in a horizontal position during the transport. Do not store or handle the machine except on its feet.
- During transport protect the carton and machine from impact drops, crushing, shocks, moisture and exposure to extreme temperature.

## Delivery inspection

- Upon receipt and delivery ensure that the machine is in the exact condition described in the enclosed documentation, and that all accessories are included. Missing items should be reported to the manufacturer or dealer immediately.
- Damage caused during transport should be reported to the shipping agent and the machine's distributor immediately.
- Packaging materials are potentially dangerous and should be kept away from children.
- The carton and all packing materials are recyclable and should be returned to a recycling center for disposal.

# INSTALLATION

## Positioning

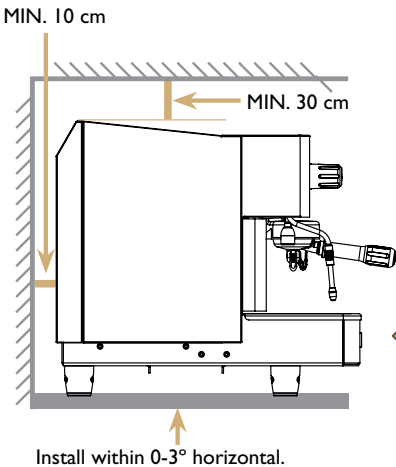

- Install the machine on a level, sturdy, and water-resistant surface approximately 110cm above floor level for ease of access and usage.
- Adjust the feet to ensure that it dispenses coffee evenly to all cups.
- Ensure enough free space is available above (>30cm) and behind (>10cm) the machine to ensure easy cleaning and maintenance and adequate ventilation.
- Do not install the machine if it is wet or damp. Allow it to dry completely and ask a service technician to ensure that none of the electrical components have been affected.



### Note:

Leave an air gap of at least 30cm above the machine and 10cm behind it to ensure adequate ventilation. The machine must be installed within 3° of horizontally level front-to-back and side-to-side to ensure proper hydraulic function and drainage. Confirm with a spirit level or digital angle gauge.

## Electrical installation

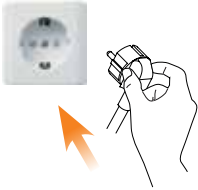

The coffee machine should only be connected to the power supply by qualified personnel. The following safety instructions should be followed at all times:

- Check that the electrical specifications on the ratings plate match the specifications of the power supply at the point of installation.
- The coffee machine must be connected to an earthed socket that complies with the regulations in force in the country of installation.
- You should protect the electric line of the installation with a circuit breaker switch appropriated for the power consumption of the machine, specified on its ratings plate.
- A residual current circuit breaker must be installed in accordance with the characteristics of the area of the installation.
- Check the characteristics, power rating of the system and that the diameter of the cables are suitable for the power used by the machine.
- Do not connect the coffee machine to the power supply via extension boards, adapters or shared sockets.

The manufacturer will not be held liable for damage to persons, animals or property resulting from incorrect installation of the machine.



### DANGER!

If the mains cable or plug is damaged, it must be replaced by the manufacturer, its service agent or similarly qualified persons in order to avoid possible **SERIOUS INJURY OR DEATH!**

## Connection types

- Connect the machine as per the instructions on the ratings plate.

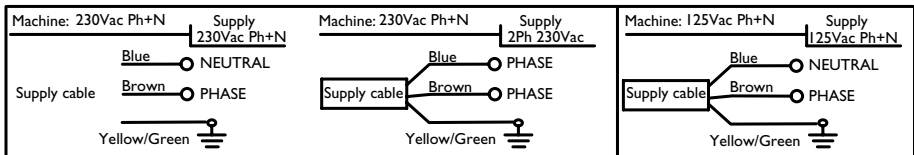

## Water connection

- The Installation of the machine to a water mains connection must be done by a qualified person.
- Rinse around 20 liters of water from the main water supply before connecting the machine to the water connection.
- Connect the inlet hose that is assembled in the machine to the main water supply, which should have a 3/8" male connection fitted with a shut-off valve, tighten it with a wrench.
- Use safe drinking water with hardness between 5°fH and 8°fH (French hardness degrees). If the value is below this limit, the presence of corrosion of hydraulic components is a possibility. If the value is higher than this limit, the presence of lime in the boiler will increase. In both cases the operation of the machine and coffee quality will be affected negatively.
- If necessary, connect the machine to a water softener or remineraliser to reduce water hardness. Use the flexible hose that is included in the accessory box of the machine.
- Connect one end of the corrugated tube to the drain cup in the machine, connect the other to the main drainage tube at the installation area.



### Important:

- Only use the hoses supplied with the machine. Never reuse old hoses. Only use replacement hoses authorised by the manufacturer.
- Make sure that the drainage tube is not twisted and ensure that the entire tube is below the level of the drain cup.

## Pressure and temperature

- Boiler temperature and pressure are directly related (see Fig. 01).
- Machine is fitted with a pressure gauge that will display the boiler pressure, if the machine is fitted with a display it will also indicate boiler temperature.

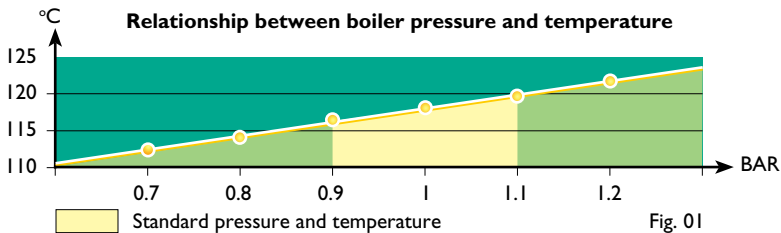

## Starting the machine

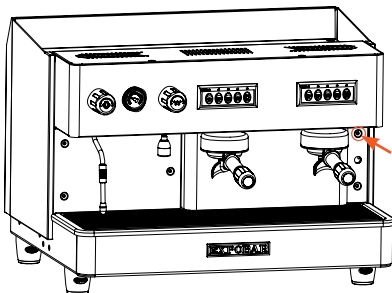

- Open the external supply of water to the machine.
- Turn on the main power switch.
- Press a drink button at the control panel on each group, wait until water comes out continuously from each of them. This way the heat exchangers in the machine will be correctly filled.
- Open the steam tap to release the air trapped in the boiler.
- The red lamp indicates that the boiler is heating. The lamp switches off when the machine reaches operating temperature.
- The machine is now ready to use.

## The portafilter set

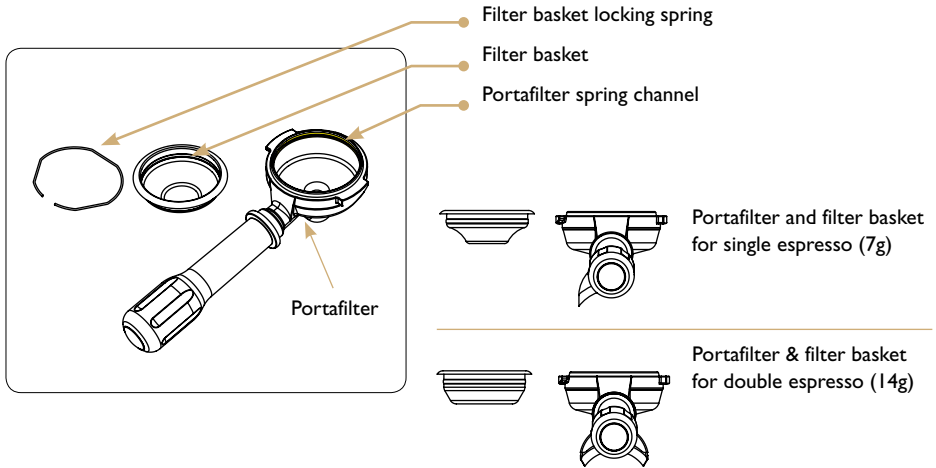

## Inserting the portafilter in the group

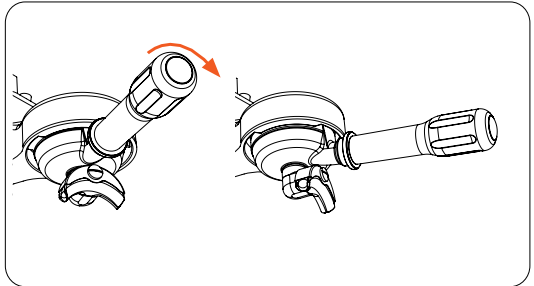
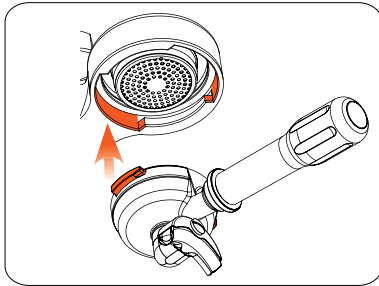

■ Align the portafilter's two flanges with the two slots in the group housing.

■ Insert the portafilter and rotate it counterclockwise until the handle is approximately perpendicular to the face of the coffee machine.

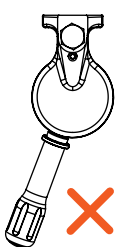

■ Portafilter not fully inserted.

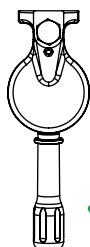

■ Correct position.

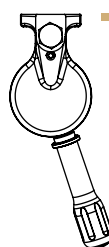

■ Group gasket is worn out, please replace.

Espresso brewing



**Important:**

Always keep the portafilter inserted in the group to keep it warm. This is important to maintain an optimal temperature when the espresso is dispensing.

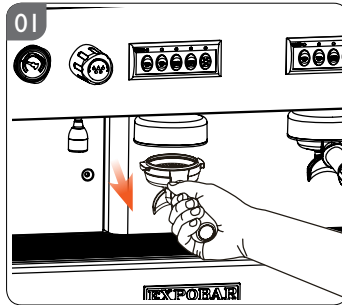

▲ Unlock and remove the portafilter from the group head.

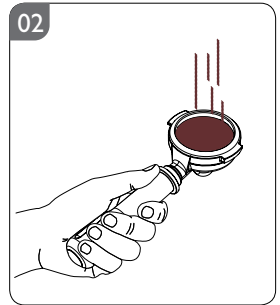

▲ Fill the filter basket with espresso-grind coffee (amount will differ depending on filter basket size). For best results use only freshly ground espresso beans.

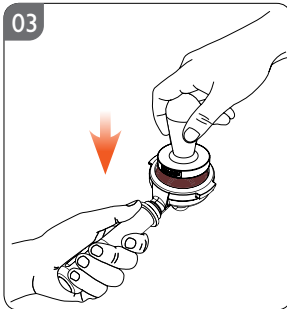

▲ Press the coffee with the coffee tamper.

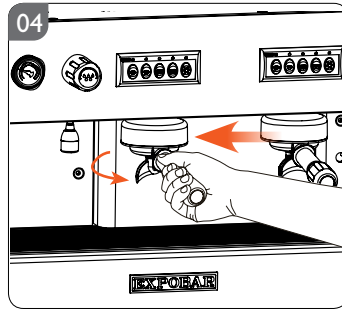

▲ Insert the filled portafilter into the group head and lock it into the correct position.

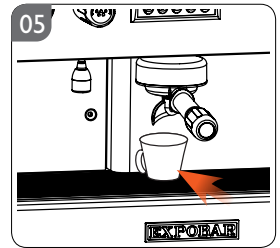

▲ Place the cup(s) under the portafilter outlet(s).

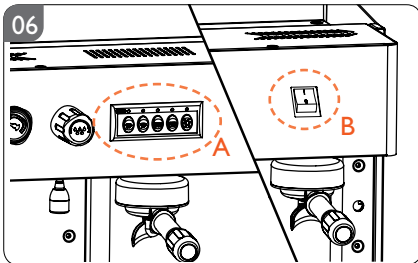

▲ Select the desired option from the drink buttons.



**WARNING!**

Never try to open the portafilter while the machine is in operation! The pressurised hot water could cause scalding or serious injury. After dispensing has finished, wait at least 3 seconds before removing the portafilter.



## Steaming and frothing milk

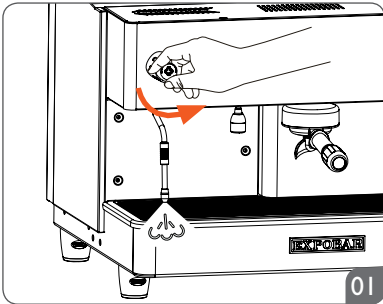

- ▲ Place the steam wand over the drip tray and open the steam lever for a few seconds to allow condensed water to be ejected. Close the steam lever when only steam comes out.

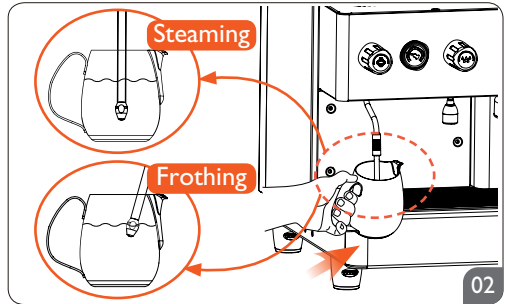

- ▲ Immerse the steam wand into the milk, making sure the wand tip is submerged.

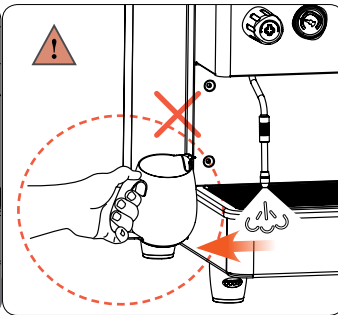
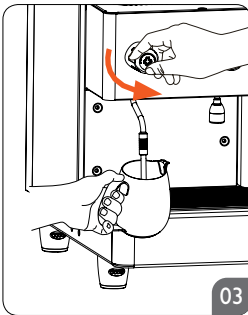

- ▲ Open the steam lever again to begin steaming or frothing the milk. Do not remove the milk pitcher while steaming.

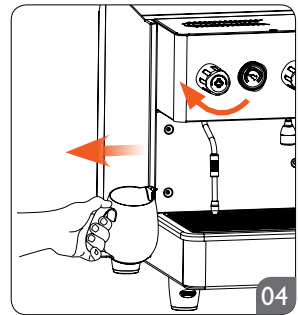

- ▲ Once the milk reaches the desired temperature, close the lever and remove the pitcher.

**! WARNING!**

Do not allow the steam wand to extend out of the milk when the lever is open, it may cause serious burns and injuries.

- ▶ After the process is finished, position the steam wand over the drip tray and open the steam lever for a few seconds to eject any milk remaining in the wand. Close the lever and then wipe down the outside of the steam wand with a damp cloth to prevent nozzle blockage and to keep it clean. Leaving milk in or on the wand will affect the taste of later drinks.

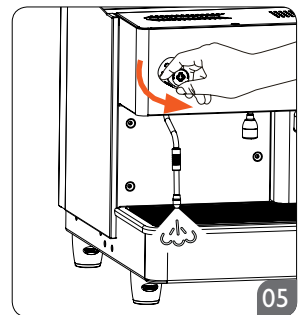

## Hot water dispensing

## Machines with manual water tap

- Place a jug (or similar) under the hot water outlet
- Open the hot water tap.
- Close the tap as soon as the machine has dispensed the desired amount of water.

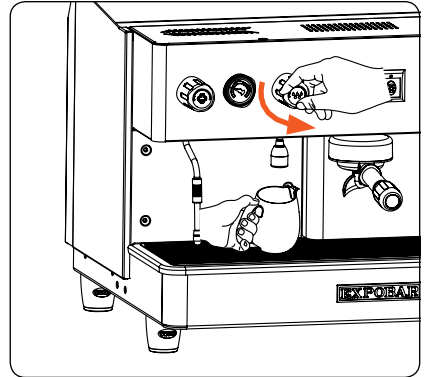
**WARNING!**

Never expose hands and fingers directly under the water outlet during operation to avoid scalding or serious burns.

## Coffee machine cleaning



### *Important:*

- To keep the machine looking and working like new, you should always follow the cleaning and care instructions provided in this manual.
- Always turn off the main power switch when cleaning the exterior of the machine.
- All external surfaces should be cleaned with a damp, lint-free cloth that will not scratch the machine.
- Do not use aggressive cleaning detergents, solvents or degreasers. These can damage the surfaces, and plastic and rubber parts, and leave unwanted residue.



### *Important:*

Each day, or 8 hours after dispensing the last coffee, the following cleaning tasks should be performed to maintain the quality and performance of the water system:

- **Portafilter:** Brew one espresso with the filter empty (around one minute) to flush it out (dispose of this water).
- **Steam Wand:** Position the wand over the drip tray and open the steam lever for one minute to flush the wand.
- **Hot Water Outlet:** Place a container under the water outlet and open the lever for 20 seconds (dispose of this water).

## Daily cleaning

- Rinse each of the brewing groups, shower plates, and portafilters with hot water for 15 seconds.
- Clean the external surfaces of the machine with a damp cloth, paying special attention to the stainless steel parts.
- Clean the steam wand and the water tap. Be sure that the nozzles are not clogged or partially blocked with milk or other residue. If it's necessary to remove them for cleaning, be careful not to deform or damage any of the components during removal.
- Clean the drip tray and the stainless steel insert grid under running water with a brush.
- Clean the drain cup by slowly pouring one liter of warm water into it to dissolve and remove the coffee residue that accumulates inside the drain cup and hose.

## Weekly cleaning



- Clean the brewing group and portafilter with professional cleaning powder (page 20).

## Cleaning and descaling the brewing group and portafilter



### WARNING!

Never try to remove the portafilter while the group is performing the cleaning operation, as the pressurized hot water could cause scalding or serious injury. After cleaning has finished, wait at least 3 seconds before removing the portafilter.

- Unlock and remove the portafilter from the group head.
- Place the cleaning membrane in the filter basket.
- Fill the filter basket with professional cleaning detergent (7gr. for a single espresso portafilter, 14gr. for double espresso portafilter). Detergent is available from your distributor as Part # 1104162.
- Lock the portafilter into the group head.
- To activate the cleaning and descaling program:
  - 1.) Turn off the machine at the main switch.
  - 2.) Press and hold down the 2 Short Espressos button  on the control panel of the group requiring cleaning. Without releasing the button, turn on the machine. Auto-cleaning will start automatically.
  - 3.) Release the button. The machine will clean, flush, and rinse itself.
  - 4.) If any residual powder is present, simply rinse the portafilter under clean water and press the Continuous Dispensing  button and allow it to flow for 15 seconds with no portafilter in place. **OR**, simply repeat steps 1 through 3 with using any detergent to rinse the group and portafilter.
  - 5.) When all cleaning/descaling is complete, remove the blind gasket and store it in a secure place.



### Important:

Boiler descaling is only to be performed by a qualified technician, and frequency will depend on local water conditions and frequency of machine use. Contact your distributor for boiler descaling questions and technical assistance.



### Note:

- Clean the group and portafilter with detergent once a week.
- For daily cleaning, rinse the group and portafilter without detergent (only using the membrane and hot water) by making .

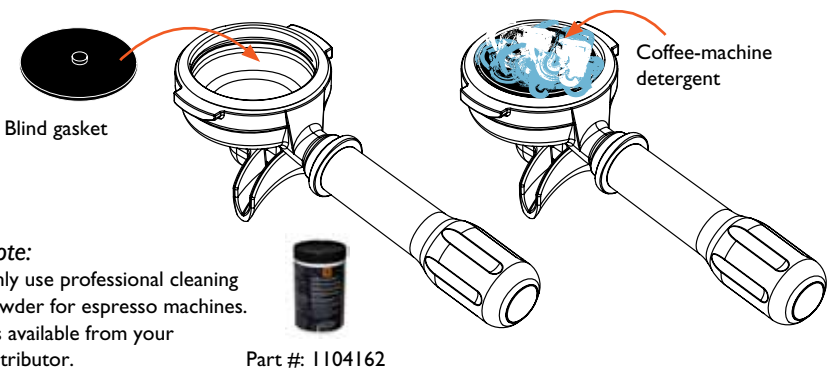

### Note:

Only use professional cleaning powder for espresso machines. It's available from your distributor.



Part #: 1104162

## Cleaning the gasket and shower plate

### Cleaning the gasket

While making espresso, coffee grounds will naturally accumulate on the group's sealing surface. Allowing an excessive amount of grounds to build up can prevent the portafilter from properly sealing to the group head. In extreme cases, such as leaving a used portafilter in the group head for several days, water can even become blocked from passing through the shower plate.

To prevent these problems, perform the following cleaning procedures daily:

- Install the blind basket into the portafilter without cleaning powder.
- Place the portafilter loosely in the group head - do not close it fully.
- Press the Continuous button .
- Perform an opening-closing motion with the portafilter in place without closing it fully. Water will flow over and around the portafilter, passing through the closing surface and washing out any coffee residue. Be very careful to avoid splashes, as this water is very hot and can cause burns.
- Press the Continuous button  again to stop the water flow.

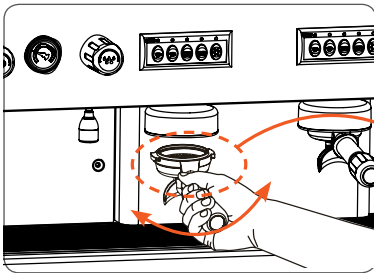

### WARNING!

Take special care to avoid scalding when performing this cleaning operation, as the hot water used to clean the gasket will spill over the sides of the portafilter.



### WARNING!

Do not fully tighten the portafilter. If fully tightened, high-pressure water may spray out and cause scalding or serious injury.

### Cleaning the shower plate

- Remove the portafilter from the group head.
- Clean the shower plate and group gasket with a soft brush to remove any coffee residue.

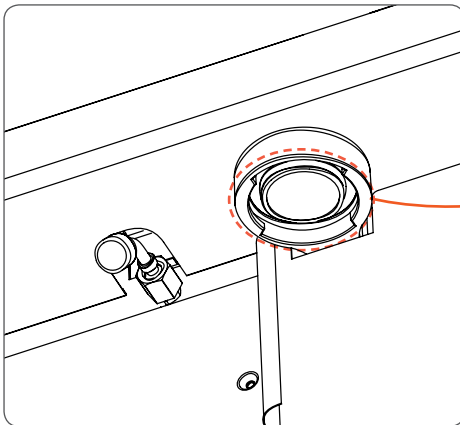

Remove coffee residue with a food-safe brush

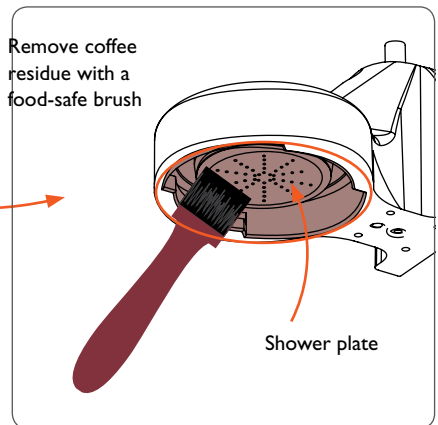

Shower plate

## Additional handling of the machine

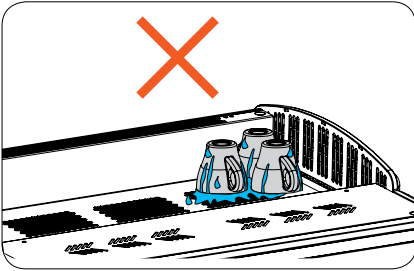

- Always remove and insert the portafilters gently. Never use excessive force to try to close the portafilter. If the portafilter does not turn and lock into place without excessive force this usually indicates that there is too much coffee in the filter basket.



**Important:**

Do not place wet cups directly on the cup shelf. Allowing water to drip into the machine can cause mechanical and electrical damage.

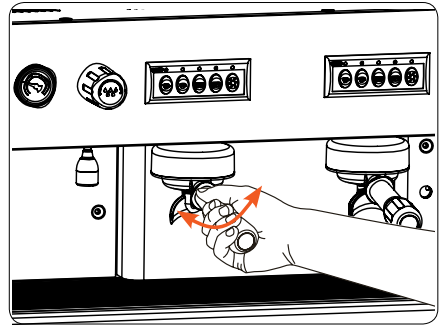

## STORAGE AND DISPOSAL OF MACHINE

### How to store the machine

Before storage be sure to:

- Perform all weekly and periodic cleaning procedures described in this manual (see pages 16-20).
- Disconnect and roll up the power cord (this should be performed by a qualified person).
- Disconnect the machine's water inlet hose from the domestic water supply and drain the boilers (this should be performed by a qualified person).
- Clean the drip tray and exterior of the machine to remove any coffee or other residue.
- Cover / re-pack the machine in its original carton and store it in a dry place where it will not be exposed to extreme temperatures or humidity.
- When returning the machine to service after long-term storage, perform all weekly and periodic cleaning procedures before use.

### Disposal of machine

- Disconnect and roll up the power cord (this should be performed by a qualified person).
- Disconnect the machine's water inlet hose from the domestic water supply and drain the boilers (this should be performed by a qualified person).
- Pack up and ship/deliver the machine to a certified recycling center.



## Buttons functions

The following functions can be programmed and controlled from the digital display:

- Volume control of four different espresso drinks per brewing group.
- Timed hot water dispensing.
- Automatic boiler filling and level control.
- Automatic heating element shut-down in event of a low water condition.
- System supervision through messages, warning, and alarms.
- Automatic cleaning of the brewing groups.

The digital controller is programmed with four standard drink functions (these can be reprogrammed as desired by the user) and one continuous function from the manufacturer.

The left four buttons (1 Short Espresso, 1 Long Espresso, 2 Short Espresso, 2 Long Espresso) will brew the programmed beverage volume and then stop automatically.

The center button (Continuous) brews continuously until the user stops it by pressing the button again.

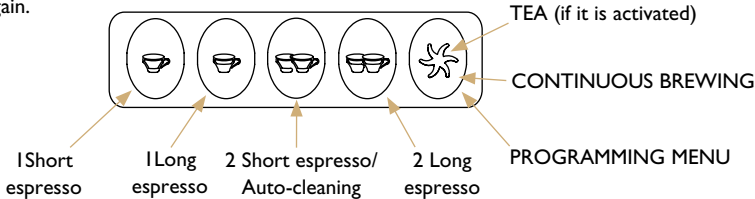

The Continuous Dispensing button performs 3 different functions (depending on length of time pressed):

### Machines equipped with display





- Under 1 second: Enables automatic water- or steam-dosing (only on machines without manual taps).
- Between 1 and 8 seconds: Enables Continuous Dispensing (press again to disable).
- Over 8 seconds: Access coffee-dose programming menu (see below).

### Machines not equipped with display

- Under 4 seconds: Enables Continuous Dispensing (press again to disable).
- Over 4 seconds: Access coffee-dose programming menu (see below).

## Additional button functions

To activate these functions, turn off the machine at the power switch then, while holding down the required button on the left-hand Drink buttons, turn the machine back on.

-  1 Short Espresso. Enable electronic pre-infusion.
-  1 Long Espresso. Disable electronic pre-infusion.
-  2 Short Espresso. Perform auto-cleaning.
-  2 Long Espresso. Turn on/off flashing of button lights (only for 2GR and 3GR machines without display control).



Note:

In machines equipped with a display, electronic pre-infusion may have to be enabled/disabled from the service programming menu.

## Programming the coffee dosage

This section explains how to program the doses dispensed automatically by the drink buttons.



### *Important:*

Use a portafilter filled with fresh coffee for every new dose you program.

- On machines not equipped with a display, hold down the Continuous Dispensing button  for 4 seconds. On machines equipped with a display, hold down the Continuous Dispensing button for 8 seconds. The Continuous Dispensing button light will flash. On machines equipped with a display, all of the Drink buttons lights will be turned on.
- Press the dispensing option that you wish to program: 1 Short Espresso, 1 Long Espresso, 2 Short Espressos or 2 Long Espressos. The lights on the button pressed and on the Continuous Dispensing button will remain on.
- The group will start dispensing coffee. When the desired volume is reached in the cup, press the selected button again to stop dispensing. This volume setting will be saved. On machines equipped with a display, the lights on the reprogrammed dosage buttons will remain off.
- Repeat this process for all of the dispensing options that you wish to reprogram.

If you only need to reprogram one of the dispensing options, follow the steps above and program just that option. All of the other dispensing options will remain unchanged (default settings).



### *Note:*

Programming any of the options on the left-hand Drink buttons (when viewing the machine from the front) automatically sets the dispensing volumes on all of the other Drink buttons. This only applies to the left-hand Drink buttons. Programming other Drink buttons only modifies the option selected.



The following checks can be carried out by users only after the machine has been turned off and disconnected from the power supply. For all other nonspecific machine faults, disconnect the machine from the power supply and immediately contact authorised and qualified service personnel.

Problem	Possible cause	Solution
The machine does not start up	The plug is not correctly inserted into the power socket	Check that the plug is correctly inserted and that the power socket is operational.
	The circuit breaker and/or differential are disconnected.	Check that they are connected.
	The cable and/or plug are damaged.	Call service personnel to replace them.
The steam wand does not dispense steam	The steam wand is clogged by milk	Clean the wand and, if necessary, remove the nozzle and unclog it using a pin or needle.
Water is found underneath the machine	The drainage tube is blocked.	Clean the drainage tube.

#### Faults produced by limescale

Coffee not dispensed at right temperature:	Heat-exchanger outlet pipes clogged by limescale.
Brewing groups do not dispense water:	Water system is clogged by limescale.
<i>90% of faults are due to limescaling inside the coffee machine (due to not softening the water). To avoid these faults, maintain the water softener regularly.</i>	

#### Coffee-grinding problems

Coffee dispensing is very fast:	The coffee grinding is too coarse. Adjust the coffee-grinding setting.
Coffee dispensing is very slow:	The coffee grinding is too fine. Adjust the coffee-grinding setting.

For the warranty to be valid the conditions for maintenance must have been followed according to our instructions, proper precaution has been made and warranty claim been issued without delay.

The affected equipment may not be used during awaiting service if there is any risk that the damage or defect would worsen.

The warranty will not cover consumption supplies such as glassware, normal maintenance such as cleaning of filters, contaminations in water, lime, incorrect voltages, pressure or adjustment of water amounts.

The warranty will not cover damages of defects caused by incorrect handling and operation of the appliance.

**FOR SERVICE**  
**Please contact your dealer**

**Your dealer**

-----  
-----  
-----



[www.creminternational.com](http://www.creminternational.com)