

## IMPORTANT INFORMATION

**WARNING:** Read the instructions carefully before installing and using the appliance.

This use and maintenance manual is an integral part of the appliance and was written to provide all the necessary relevant information and instructions.

Keep it carefully for future reference by the various operators and for the entire expected service life of the oven.

The appliance is intended for professional use and must be used by trained and qualified personnel. Users are required to read and understand the information contained herein and apply it correctly. Smeg SpA reserves the right to make modifications at any time, such as changing, deleting or adding wording, without notice.

Should the need arise to contact Smeg SpA, the contact details and methods are as follows:

Smeg SpA - Via Leonardo da Vinci, 4 42016 Guastalla (RE) Italy

Tel. +39 0522 8211 - Fax +39 0522 821453

website: <https://www.smegfoodservice.com/>

email: [foodservice@smeg.it](mailto:foodservice@smeg.it)

Our Sales Office staff will be happy to provide you with information and instructions about how to operate your appliance correctly or, if necessary, put you in contact with your nearest Authorised Service Centre. The full range of our products can be found on our website.

Per Australia:

INFORMATION AND SERVICE FOR SMEG PROFESSIONAL DISHWASHERS

all sales and after sales enquiries for australian customers, please see below contact details:

Smeg Australia Pty Ltd

2-8 Baker Street, Banksmeadow 2019 NSW

Ph: 02 8667 4888 or 0414 147 634

email: [foodservice@smeg.com.au](mailto:foodservice@smeg.com.au)

# Technical Data

## TECHNICAL DATA

|   |  |
|---|--|
| DESCRIPTION                             | SPO5*  |
| WEIGHT                                  | 95 kg  |
| CAVITY INTERNAL DIMENSIONS<br>L X D X H | 670 X 560 X 420 mm   |
| INTERNAL VOLUME                         | 0.157 m <sup>3</sup>   |
| POWER SUPPLY                            | 380-415V 3N ~ /50-60 HZ (DEFAULT)<br>220-240V 3 ~ /50-60 HZ  |
| NOMINAL POWER                           | P <sub>MAX</sub> 8700W ---at 415V<br>P <sub>MAX</sub> 8000W----at 400V<br>P <sub>MAX</sub> 7300W-----at 380V |
| RATED CURRENT                           | I <sub>(max)</sub> 17 A (DEFAULT)<br>I <sub>(max)</sub> 31 A   |
| SOUND PRESSURE LEVEL                    | <70 dB   |
| N° TRAYS                                | 5 SIZE GN 1/1 (standard)<br>4 SIZE 600 X 400 mm (optional)   |
| DISTANCE BETWEEN TRAYS                  | 70 mm (GN 1/1)<br>90 mm (60 X 40)  |
| PROTECTION RATING                       | IPX4   |
| COOKING TYPES                           | CONVECTION<br>CONVECTION - STEAM<br>STEAM  |
| MAXIMUM FOOD LOAD                       | GASTRONOMY: 20 kg<br>PATISSERIE: 8 kg<br>BAKING: 8 kg  |
| N° AUTOMATIC WASHING PROGRAMS           | 4 + RINSE  |
| USE                                     | INDOOR   |
| AMBIENT TEMPERATURE OF USE              | 10°C - 35°C  |
| RELATIVE HUMIDITY (PLACE OF USE)        | 80% FOR TEMPERATURES UP TO 25°C<br>WITH A LINEAR REDUCTION TO 50% AT<br>35°C                                 |
| MAXIMUM ALTITUDE OF USE                 | 2000 m   |
| WATER SUPPLY PRESSURE                   | 200 kPa - 1000 kPa (2 bar - 10 bar)  |

# Technical Data

The identification plate must not be removed for any reason. It contains all the essential information necessary for identifying the product.

## IDENTIFICATION PLATE

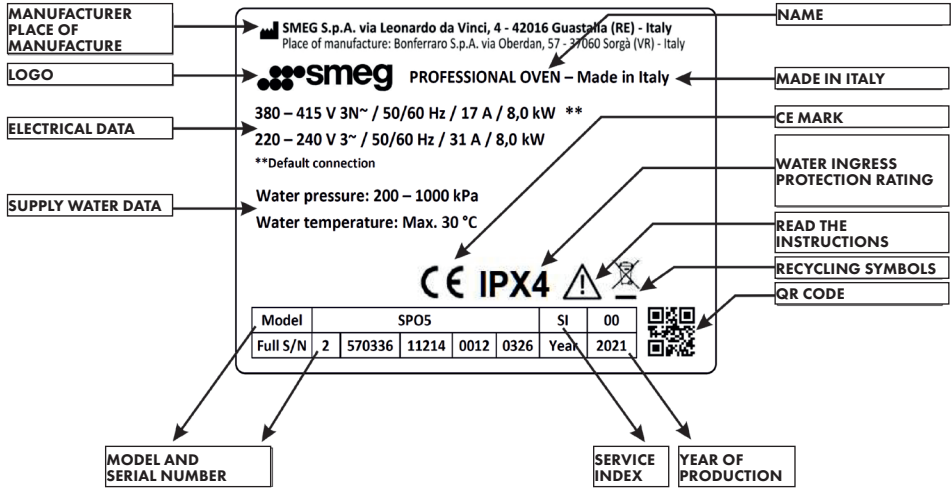

| MODEL                        | * SPO5L2SDL | * SPO5L2S |
|------------------------------|-------------|-----------|
| Width                        | 790 mm      | 790 mm    |
| Height                       | 644 mm      | 644 mm    |
| Depth                        | 957 mm      | 914 mm    |
| Maximum depth with door open | 1623 mm     | 1581 mm   |

# How to read the manual

Pictograms used in the manual and/or on the appliance:



Safety warning, which if not complied with can be hazardous.



Electric shock hazard



Danger of burns



Connect the parts together that are normally at ground potential



Description

Description of the appliance and its accessories.



Use

Information on the use of the appliance and its accessories.



Cleaning and maintenance

Information for proper cleaning and maintenance of the appliance.



Installation

Information for the qualified technician: Installation, operation and inspection.



Information



Advice

# Preliminary operations

## TRANSLATION OF THE ORIGINAL INSTRUCTIONS

### BEFORE USE

Read this use and maintenance manual carefully before doing anything with the product. This manual is an integral part of the product.

The user manual should be kept carefully and referred to whenever necessary.

1. Remove any protective film from the outside or inside of the appliance, including accessories.
2. Remove any labels (apart from the identification plate) from the accessories and from the oven cavity.
3. Remove all the accessories from the appliance and wash them.

After installation, first wash the appliance with original "Smeg professional cooking" detergent to check the tightness of the seals of the hydraulic connections and the appliance.

Go to the next point only after having done this.

When using the appliance for the first time, heat the empty oven to maximum temperature and let it run for about 1 hour. This should be done to eliminate any odours remaining from products used during production. If the oven malfunctions, contact technical support.

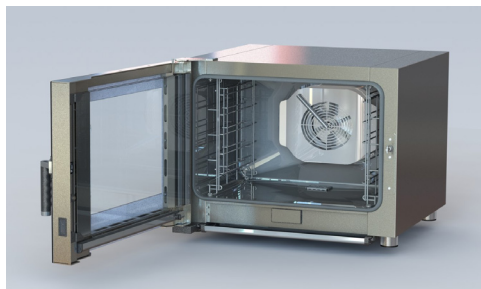

# Contents

|          |  |           |
|----------|--|-----------|
| <b>1</b> | <b>INSTRUCTIONS</b>  | <b>10</b> |
| 1.1      | GENERAL INSTRUCTIONS                                       | 10        |
| 1.2      | INTENDED USE   | 10        |
| 1.3      | UNPACKING  | 11        |
| 1.4      | POSITIONING  | 11        |
| 1.5      | ROUTINE MAINTENANCE  | 12        |
| 1.6      | RESIDUAL RISKS   | 13        |
| 1.7      | IDENTIFICATION PLATE                                       | 14        |
| 1.8      | MANUFACTURER'S LIABILITY                                   | 14        |
| 1.9      | DISPOSAL   | 14        |
| 1.10     | THIS USER MANUAL   | 15        |
| <b>2</b> | <b>DESCRIPTION</b>   | <b>16</b> |
| 2.1      | GENERAL DESCRIPTION  | 16        |
| 2.2      | OTHER PARTS  | 17        |
| <b>3</b> | <b>USE</b>   | <b>21</b> |
| 3.1      | USING THE OVEN   | 21        |
| 3.2      | COOKING MENU   | 23        |
| 3.3      | SETTING MULTI-COOKING                                      | 38        |
| <b>4</b> | <b>CLEANING AND MAINTENANCE</b>                            | <b>42</b> |
| 4.1      | AUTOMATIC WASHING FUNCTION                                 | 42        |
| 4.2      | EMPTYING RESERVOIR   | 43        |
| 4.3      | WASHING DETERGENT RESERVOIR                                | 44        |
| 4.3.1    | EXTERNAL DETERGENT SUPPLY                                  | 45        |
| 4.4      | FILLING THE RESERVOIR USING A CONTAINER OF DETERGENT       | 45        |
| 4.5      | CLEANING THE APPLIANCE                                     | 46        |
| 4.5.1    | CLEANING THE DOOR  | 46        |
| 4.5.2    | CLEANING THE DOOR DRIP TRAY                                | 47        |
| 4.5.3    | CLEANING THE REMOVABLE DRIP TRAY AT THE BOTTOM OF THE OVEN | 47        |
| 4.6      | CLEANING THE OVEN CAVITY                                   | 48        |
| 4.7      | EXTRAORDINARY MAINTENANCE                                  | 48        |
| <b>5</b> | <b>SETTINGS MENU</b>                                       | <b>50</b> |
| 5.1      | SETTING THE DATE / TIME                                    | 51        |

# Contents

|          |                                      |              |
|----------|--------------------------------------|--------------|
| <b>6</b> | <b>INSTALLATION</b>                  | <b>52</b>    |
| 6.1      | ELECTRICAL CONNECTION                | 52           |
| 6.2      | CONNECTING TO THE MAINS POWER SUPPLY | 53           |
| 6.3      | CONNECTING TO THE WATER SUPPLY       | 56           |
| 6.4      | CONNECTING TO THE DRAINAGE SYSTEM    | 57           |
| 6.5      | POSITIONING                          | 58           |
|          | <b>ERROR MESSAGES AND FAULTS</b>     | <b>61-62</b> |



## Instructions

### 1. INSTRUCTIONS

#### 1.1 GENERAL INSTRUCTIONS

- Read this manual carefully.
- This manual is an integral part of the appliance. It should be kept in its entirety and in an accessible place until the appliance is disposed of.
- Read the instructions in this manual carefully before installing and using the appliance. Failure to read, understand or correctly interpret the instructions contained in this manual may cause damage to the appliance and the surrounding environment, as well as be a source of danger for the operator.
- Installation, maintenance and any repairs should be carried out by authorized technical personnel. Maintenance or repairs attempted or carried out by non-authorized personnel, in addition to invalidating the warranty, can cause damage to the appliance and the surrounding environment, as well as be a source of danger for the operator.
- Only original spare parts must be used when replacing components.

- The manufacturer cannot be held liable for uses other than those indicated in this manual.
- Before use, make sure that there are no instructions booklets, bags or anything else inside the appliance, including any detergent residues. Make sure that the exhaust opening is not obstructed.
- If the appliance malfunctions, operates incorrectly or shows signs of structural damage, disconnect the power supply and contact an authorised technical assistance centre.

#### 1.2 INTENDED USE

- This appliance is intended for professional use for preparing and cooking food such as in the kitchens of restaurants, canteens, hospitals and commercial enterprises such as bakeries, pastry shops, butchers' shops etc. All other uses are considered improper and non-compliant.
- The appliance must only be used by qualified personnel who have undergone specific training.





## 1.3 UNPACKING

- Remove all packaging and any polystyrene protection before installation.
- Make sure that the appliance has not been damaged during transport. If it has been damaged, inform the carrier and/or the dealer immediately.
- Packaging materials must be disposed of according to current regulations.

## 1.4 POSITIONING

- The room where the appliance is installed must be well ventilated and have permanent air vents. The electrical, plumbing and ventilation systems must be compliant with current plant installation and work safety regulations.
- The oven is designed to be used on a table or suitable stand in stationary indoor locations.
- Carefully remove the special film that protects the stainless steel components, making sure that there are no glue residues left on the surfaces. If necessary, remove residues using an appropriate non-flammable solvent. Do not use tools that could scratch the surfaces or abrasive or acid-based cleaning products.

- Take into account the weight of the appliance before moving it manually in order to avoid risks for the persons handling it.
- Personnel not involved in the operation should not be permitted to access the area during installation.
- The appliance is not suitable for built-in installation.
- The appliance is designed to be placed on a support such as a table or a stand. Do not position the appliance directly on the floor.
- Do not install the appliance close to other equipment that can reach high temperatures (e.g. fryers) and/or develop/emit steam (e.g. pasta cookers).
- The appliance must not be placed directly above an oven or other heat sources. Some models or combination of models can be used in a stacked configuration by installing the original "Smeg Foodservice" stacking kit. For further information regarding this type of installation, please contact your dealer or Smeg Foodservice.
- If the appliance is to be installed close to walls, shelves, counters and the like, these



## Instructions

must be made of non-flammable and heat resistant materials. Otherwise, they should be protected by a suitable coating. All interventions involving heat containment works should comply with the current fire prevention regulations.

- Make sure that the support surface is suitable for the size and weight of the appliance and that it is perfectly level. Use a spirit level to check that it is level and correct if necessary.
- The appliance rests on the surface on four feet. These must not be removed. Do not operate the appliance without the feet installed.
- To assist the circulation of air around the appliance, leave a clearance of at least 10 cm between the sides of the appliance and the surrounding walls or other appliances, and between the back of the appliance and the rear wall.
- The appliance must be positioned so that the rear wall is easily accessible for any maintenance that needs to be carried out.
- The maximum working height, with reference to the highest level of the useful work surface, should not be more than

1.6 metres from the floor. If the working height is higher than this, after the appliance has been installed, apply the appropriate adhesive label (supplied with the product) at a height of 1.6 metres.



- Cooking produces fumes, hot vapours and odours, which are extracted through the exhaust. Check if there are regulations that require a hood to be installed above the oven. If an extraction system (hood) is required and is not already present, Smeg recommends the use of Smeg professional hoods ([www.smegfoodservice.com](http://www.smegfoodservice.com)).

### 1.5 ROUTINE MAINTENANCE

- Checking the appliance regularly helps to extend its service life and ensures that it operates correctly. It is recommended that you have the appliance inspected at least once a year and to have any necessary maintenance carried out by an authorised technical assistance centre. Have it inspected at more frequent intervals in case of intensive use.
- All maintenance should be carried out by qualified and



trained personnel and in compliance with plant installation and work safety regulations.

- Before carrying out any maintenance on the appliance, it must be disconnected from the power supply and allowed to cool down.
- The appliance contains electronic components. Do not clean it using jets of water or steam.
- The manufacturer is not liable for malfunctions due to improper or poor maintenance.

## 1.6 RESIDUAL RISKS

- To reduce the risk of injury, always use the most appropriate personal protective equipment (PPE) for the task to be carried out.
- Always open the door very slowly to avoid burns due to hot vapours.
- When handling the cooking cavity washing detergent, carefully follow the instructions provided on the detergent safety data sheet.
- Do not pour liquids directly onto very hot trays, nor inside the oven, especially after it has been operating at high temperatures.
- Do not use plastic cookware or containers when cooking food.

- Do not place containers with liquids or food products that may melt during cooking on the upper shelves, which are not visible.
- If the appliance is placed on a table or on a support that is fitted with wheels, make sure that it cannot move and that any unexpected movement will not damage electrical, water or other connections.
- When tray trolleys are moved, any containers with hot liquids must be closed (danger of injury and burns).
- Do not use the handle as a grip in order to move the appliance.
- Do not use flammable products and/or materials to clean the appliance.
- Make sure there are no objects or materials obstructing the exhaust.
- The safety thermostats must be reactivated only after the fault has been eliminated. These operations should only be carried out by a qualified technician.
- Faulty fuses should be replaced only after having eliminated the faults that caused them to break. These operations should only be carried out by a qualified technician.
- Do not attempt to extinguish



## Instructions

a flame or fires with water. Switch off the appliance and cover it with a fire blanket and/or use a suitable fire extinguisher.



**IF A FIRE BREAKS OUT INSIDE THE OVEN CHAMBER, DO NOT OPEN THE OVEN DOOR**

### 1.7 IDENTIFICATION PLATE

- The identification plate contains the technical data, serial number and brand name of the appliance. Do not remove the identification plate for any reason.

### 1.8 MANUFACTURER'S LIABILITY

The manufacturer declines all liability for damage to persons or property or animals caused by:

- the use of the appliance for uses other than the one specified
- failure to comply with the instructions in the user manual
- tampering with any part of the appliance
- the use of non-original spare parts
- the use of non-original accessories
- the use of non-original cleaning products

### 1.9 DISPOSAL



This appliance must be disposed of separately from other waste (WEEE directive 2012/19/EU).

The appliance does not contain substances in quantities sufficient to be considered hazardous to health and the environment, in accordance with current European directives.

Read the following carefully before disposing of the appliance:

- DISCONNECT THE MAINS POWER SUPPLY.
- REMOVE THE PLUG – SOCKET ASSEMBLY.
- CUT THE POWER CABLE.



**POWER VOLTAGE  
DANGER OF  
ELECTROCUTION**

After having done this, take the appliance to a local recycling centre for electrical and electronic waste or return it to the retailer when purchasing an equivalent product.

Our appliances are packaged in non-polluting and recyclable materials.



**PLASTIC PACKAGING  
DANGER OF SUFFOCATION**



## 1.10 THIS USER MANUAL

This user manual is an integral part of the appliance and must therefore be kept in its entirety and within the user's reach for the whole working life of the appliance.

Read this user manual carefully before using the appliance.

**NOTE:** the presence and functionality of the options shown on the display depend on the model/version purchased.



# Description

## 2 DESCRIPTION

### 2.1 GENERAL DESCRIPTION

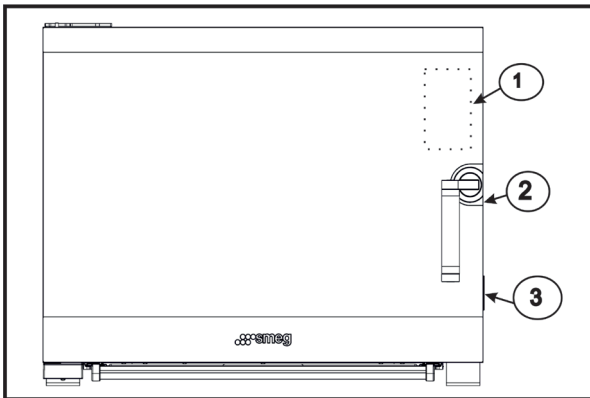

- 1 Display
- 2 Handle
- 3 USB port
- 4 Washing nozzle
- 5 Deflector
- 6 Door lock hook
- 7 Tray support frames
- 8 Tray support shelves
- 9 Removable oven bottom drip tray
- 10 Multi-point core probe input (with 4 detection points)
- 11 Detergent drawer
- 12 Drip tray valve
- 13 Removable door drip tray
- 14 LED light\*
- 15 Exhaust
- 16 Descaler bypass H2O (after-sales accessory)
- 17 Water inlet
- 18 Water drainage
- 19 Power cable
- 20 Safety thermostat

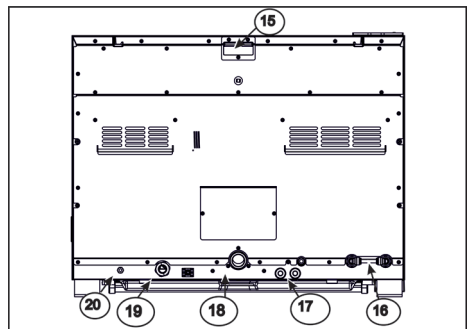
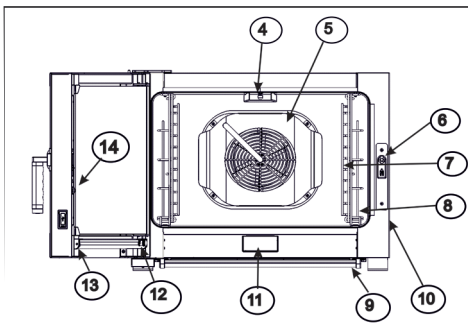

\* Located in the door



## 2.2 OTHER PARTS TRAY SHELVES

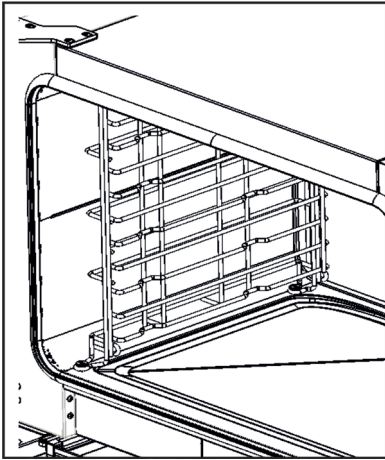

## INTERNAL VENTILATION - DEFLECTOR

When the door is opened, the ventilator automatically switches off (as do the heating elements); it starts again soon as the door is closed.

The function of the deflector is to cover the fan and direct the air / steam. It can only be removed and inspected by trained and specialized technical personnel.

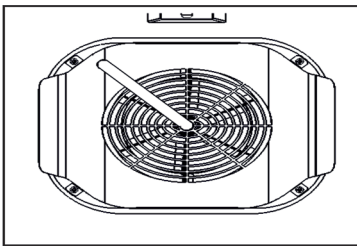

## DETERGENT DRAWER

Fill the drawer with original “Smeg Foodservice” detergent.

Top up when the indicator on the display indicates that you should do so. See below.



When using cleaning products, always wear protective equipment as recommended by the relevant health and safety regulations

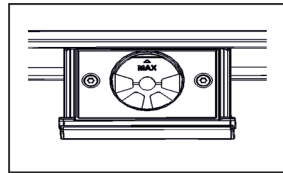



## Description

### WASHING NOZZLE

The nozzle works with the water supply pressure. Pressures lower than those indicated will affect the effectiveness of the washing.

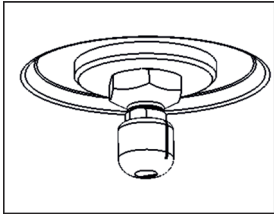

Under some circumstances, the nozzle could become clogged due to minerals dissolved in the water, preventing water from flowing out.

If this occurs, unscrew the hexagonal head using a suitable tool, inspect the nozzle and, if necessary, clean it.

### INTERNAL DRAIN AND FILTER

The filter retains coarse residues during the cooking process.

The internal drain (a) and the washing water filter (b) should be cleaned periodically at the end of cooking. The filter should be put back in the oven chamber as shown in the figure (b) before continuing to cook. The internal drain connects to the external drain outlet (c).

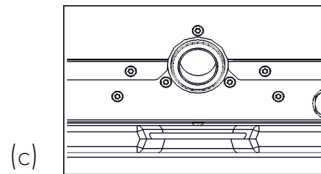
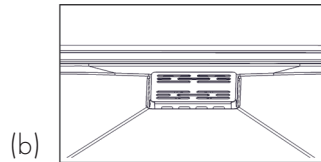
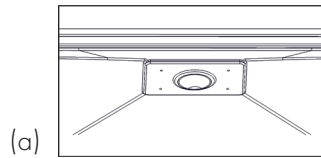





## REMOVABLE DOOR DRIP TRAY

The door drip tray collects condensation and evaporation residues that form during cooking and when the door is opened. It is fitted with a semi-automatic drain valve. The drip tray can be removed, inspected and washed.

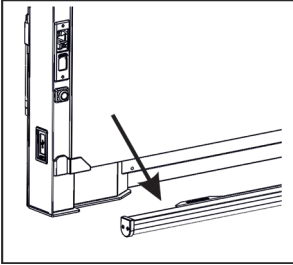

## REMOVABLE OVEN BOTTOM DRIP TRAY

The drip tray is located at the bottom of the oven to collect cooking residues. It can be removed, inspected and washed.

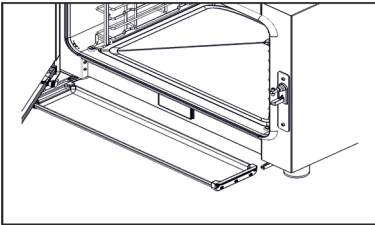

## CORE PROBE

To use the core probe, insert the connector of the probe into the special housing on the outside of the oven.

Before starting the program, insert the probe in the food.

The core probe has four temperature detection points.

We recommended that you pass the cable over the door lock.

Only rest the probe outside the oven when not in use or during preheating.

For detailed instructions, please see the attachment at the end of the manual.

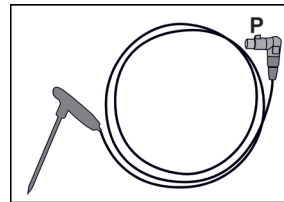
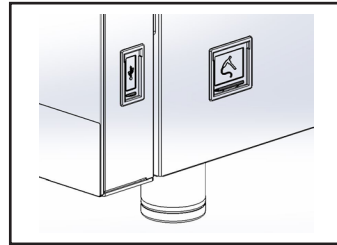

**N.B.** You have to press the release button (P) before removing the core probe from the seat.



## Description

### INTERIOR LIGHTING

Internal lighting is provided by a LED strip. If necessary, it should only be replaced by a specialized and suitably trained technician.

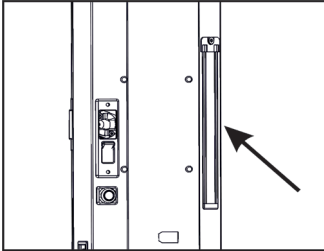

### OPTIONAL ACCESSORIES

Original optional accessories can be ordered / purchased from authorised dealers so as not to compromise the structural and functional integrity of the product.

### USB PORT

The software can be updated via the USB port.

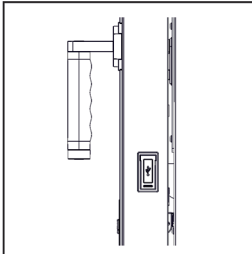



## 3 USE

### 3.1 USING THE OVEN

#### SCREEN-SAVER SCREEN

After the oven has been switched on, the software version is displayed, followed by the screen saver screen.



#### THE ON SCREEN

Touching the display brings up the following screen:

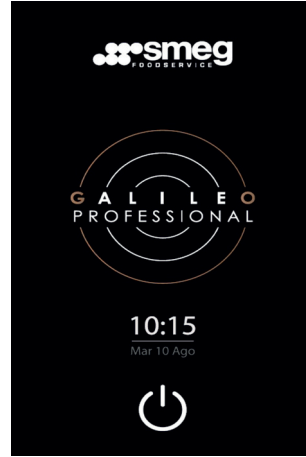

#### HOME PAGE SCREEN

Pressing and holding the ON/OFF icon (power button icon) calls up the home page screen with the main functions.

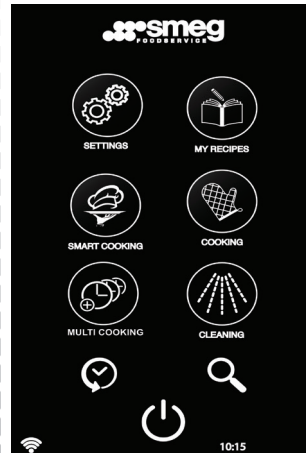



## Use

The functions are described in the following table with their respective icons:

|  |  |
|--|--|
|  | ACTIVATED or READY TO USE: pressing and holding for 2 seconds turns off the oven and switches to the ON screen.  |
|  | HISTORY (according to the model)   |
|  | SEARCH   |
|  | SETTINGS   |
|  | MY RECIPES   |
|  | SMART COOKING  |
|  | COOKING: Cooking process in which parameters are set directly (time, temperature, humidity, fan speed and exhaust, core probe and delta T adjustment). Allowing several cooking steps to be set (1 to 8) plus preheating and hold. |
|  | MULTI-COOKING  |
|  | WASHING  |
|  | DELETE   |
|  | HOME PAGE  |
|  | CONFIRM  |
|  | SAVE   |

|  |  |
|--|--|
|  | COOKING STEPS  |
|  | REPEAT   |
|  | START  |
|  | PAUSE<br>short press, pauses the cooking cycle;<br>long press, stops cooking immediately and takes you back to the home page screen. |
|  | SUMMARY  |
|  | SKIP   |

### NUMERIC KEYPAD:

When it appears, it can be used to enter the required value without having to use the cursor scroll (available only for some parameters).

### SCROLL:

When it appears, it can be used to select the required value without having to use the keypad.

Drag the cursor (dot) and release it when you reach the required value.



## 3.2 COOKING MENU

From the home screen, press .

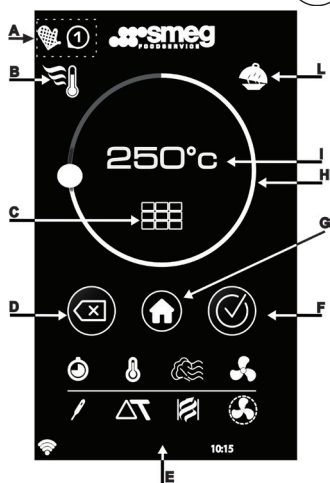

### A: Information area

Indicates the number of the step that is being set (8 steps available only in the cooking menu) and in which menu they are carried out.

### B: Pre-heating symbol

(light grey if not yet set, yellow if already set).

**C: Numeric keypad:** only available for some parameters.

When available, it can be used instead of the scroll to enter the value for the parameter.

### D: Delete entered data.

### E: Set parameters

(refer to the parameters table for their meanings).

### F: Confirm parameters

Appears if the 2 essential parameters have been set (described below). In this case, the setting for the current step is saved and you are taken to the step

summary screen.

### G: Return to the HOME PAGE

Returning to the HOME PAGE without having confirmed the data will delete any settings that were made.

### H: Setting the value

Drag the cursor of the circle and release it when you reach the required value for the parameter.

### I: Displays the set data.

### L: Hold icon.



# Use

The following cooking parameters can be set on this screen:

## PARAMETERS TABLE

|  |                      |
|--|----------------------|
|  | TIME                 |
|  | TEMPERATURE          |
|  | STEAM                |
|  | CONTINUOUS FAN SPEED |
|  | PULSED FAN SPEED     |
|  | CORE PROBE           |
|  | DELTA T              |
|  | EXHAUST OPENING      |

A maximum of 4 parameters can be activated for a step, 2 of which (e.g. time + temperature) are essential / mandatory and they must be set in order to confirm the step settings.

The pairs of parameters that must be set are as follows:

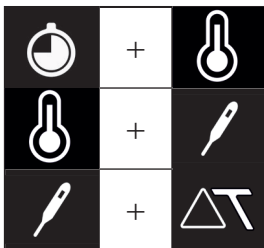

After the essential parameters have been set, the confirmation icon (✓) becomes yellow, allowing you to complete the step. It is optional whether to set the other two parameters.

If they are not set, they will be activated by default.

### NOTE:









Some parameters inhibit the use of others; e.g. time cannot be combined with the core probe.

Selecting saturated steam excludes the exhaust and continuous fan parameters.

Selecting direct steam excludes the exhaust parameter.





## PARAMETER SETTING SUMMARY:

|  |   |
|--|---|
|    | TIME<br>MIN-MAX: 0-23:59<br>STEP: 1 h for the hours 1 min for the minutes |
|    | TEMPERATURE<br>MIN-MAX: 30°C - 270°C<br>STEP: 1°C                         |
|    | SATURATED STEAM<br>DEFAULT 100%   |
|    | DIRECT STEAM<br>DEFAULT: 0%<br>MIN-MAX: 5% - 100%<br>STEP: 5%             |
|    | CONTINUOUS FAN SPEED<br>DEFAULT: 100%<br>MIN-MAX: 50% - 100%<br>STEP: 5%  |
|    | PULSED FAN SPEED<br>DEFAULT: 100%<br>MIN-MAX: 50% - 100%<br>STEP: 5%      |
|    | CORE PROBE<br>MIN-MAX: 20°C - 100°C<br>STEP: 1°C                          |
|  | DELTA T<br>MIN-MAX: 20° - 150°<br>STEP: 1°C                               |
|  | EXHAUST OPENING<br>MIN-MAX: 0%-100%<br>- DEFAULT 100%<br>STEP: 25%        |

THE PARAMETERS CAN BE SET USING THE SCROLL (AUTOMATIC SAVING) OR VIA THE KEYPAD AND CONFIRMED USING THE  BUTTON

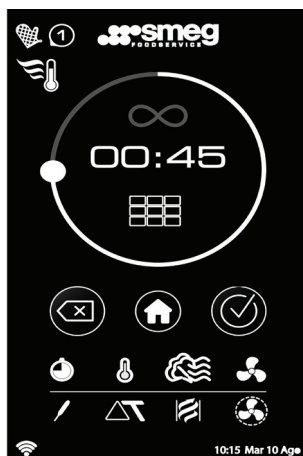
## SET TIME



This is the first screen of the cooking menu, the  icon is white.

The infinity symbol (∞) and the default value (00:00) or the previously set value are displayed.

The 2 digits on the left indicate the hours.

The 2 digits on the right indicate the minutes.

The digits of the hours and minutes become yellow when selected, indicating that the value can be changed.

The default colour for the minutes is always yellow.



## Use

### SET INFINITY

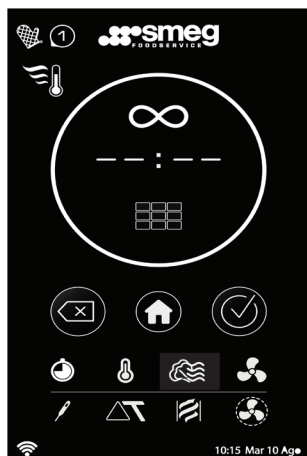

Touching the ∞ icon (becomes yellow), disables the scroll and the keypad and the time is set to infinity.

The ⌚ icon has become yellow and the parameter is saved.

Pressing the (X) icon takes you back to the previous screen.

Select another icon to continue.

### SET TEMPERATURE

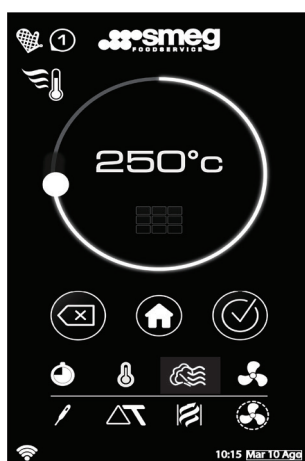

Touch the 🌡 icon (becomes white). The scroll is grey, - - - appears (default) or the previously set value is displayed. The value can be set using the circular scroll or the keypad. The parameter is stored and saved automatically when the circular scroll bar is used.

When the 🌡 icon becomes yellow, the parameter has been saved.

Minimum value 30°C, maximum value 270°C.







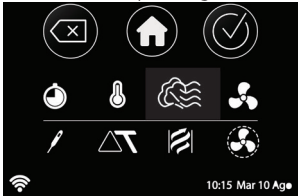

You can now:

- complete the step by pressing the confirm icon (✓) the recipe summary screen will then appear and it will be possible to start the cooking cycle (see following page)
- additional settings can be entered, for example adding pre-heating or changing optional parameters (fan speed, exhaust opening, steam settings).

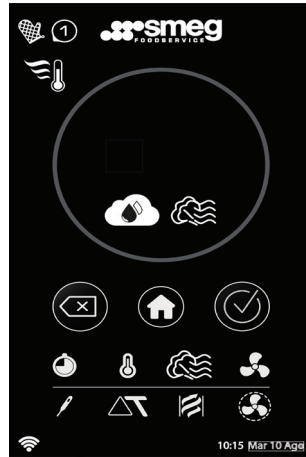

## SET STEAM



Touching the  icon causes the direct steam  and saturated steam  icons to appear.

Touching the saturated steam icon automatically sets it to 100%.

Touching the direct steam icon sets the default value of 0%. A value of up to 100% can be selected.

It is now possible to select the  button to start cooking.



## Use

### DIRECT STEAM:

It can be set for all types of cooking.

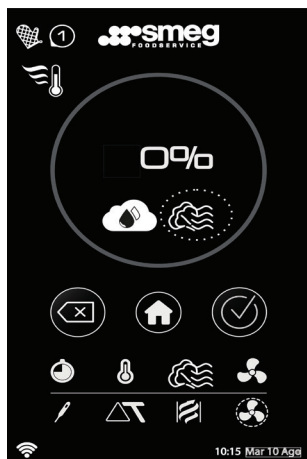

### SATURATED STEAM

Suitable for delicate cooking, with a minimum load distributed evenly on the trays. With saturated steam, the fan can be switched on to obtain pulsed ventilated saturated steam.

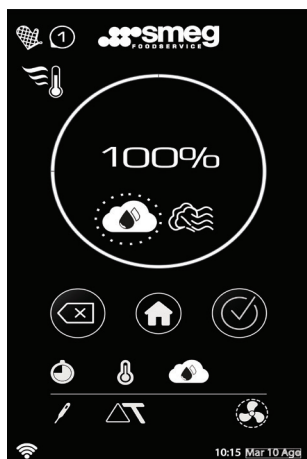

### SET CONTINUOUS VENTILATION

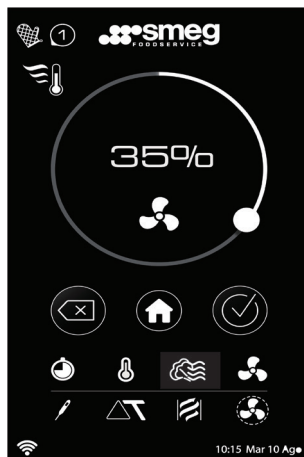

Use the circular scroll to set the required value. Min. 50%, max 100% at steps of 5%.



## SET PULSED FAN SPEED

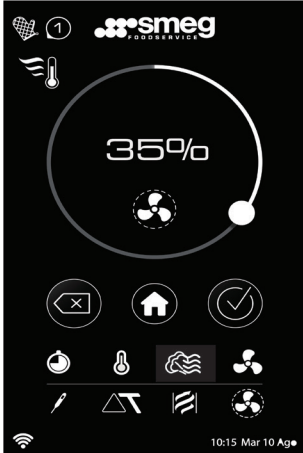

Touching the "pulsed speed" icon  (becomes yellow) sets the required value. The default value is 100%. The minimum value is 50%, the maximum is 100% and can be set in steps of 5%.

## SET CORE PROBE

Cooking with the core probe requires setting the probe temperature (min 20°C, max 100°C) and the cooking cavity (min 30°C, max 270°C).

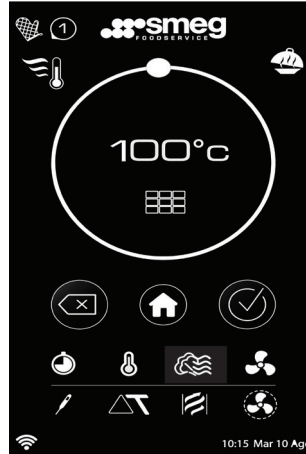

The optional parameters that can be activated are steam or exhaust opening and continuous / pulsed fan. If not selected, the default optional parameters are exhaust open 100%, continuous mode fan speed 100%. Preheating and hold can be enabled.



## Use

The following screen shows a cooking process with a core probe that has ended.

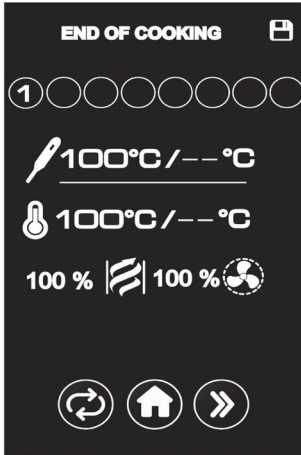

For detailed instructions, please see the attachment at the end of the manual.

## SET DELTA T

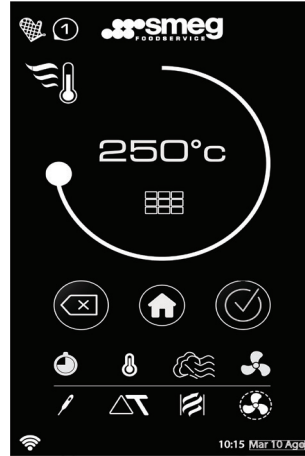

Touching the "delta T" icon (becomes yellow) sets the required value. The minimum value is 20°C, the maximum is 150°C and can be set in steps of 1°C.



## SET EXHAUST OPENING

The image of the exhaust  with the lid changes according to the percentage set (0-100%), see the images below.

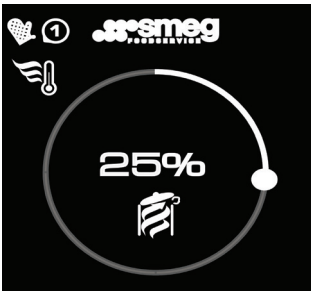
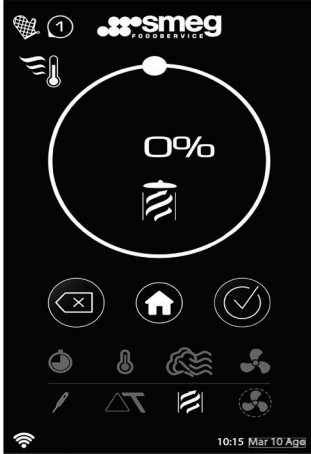

## SET PRE-HEATING



Pressing  will call up a screen similar to the set temperature screen.

The value can be set from 30° to 270°C. As soon as a temperature appears on the display, the preheat button under the information area becomes yellow (preheating activated) .



ZE



## Use

### EXAMPLE WITH SEVERAL STEPS

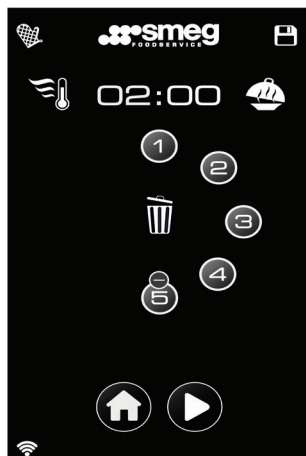

A maximum of 8 steps can be set (+ preheating + hold).

Touch the button of a step to access its summary screen from where the settings can be changed. The  button starts the cooking process.

### STEP SUMMARY

When parameters of the first step have been set, pressing the confirm button  will take you to the following screen.





- A: Total duration of the recipe.
  - B: Preheating activation / deactivation.
  - C: Information area showing the name and photo of the recipe, if a previously saved recipe was called up.
  - D: The «+» button adds a step and takes you back to the settings screen.
  - E: Hold function activation / deactivation.
  - F: Save the recipe, to which you can assign a name and associate a photo that will be displayed in zone C.
- It is now possible to save or start a cooking cycle.



## HOLD

The hold screen shows the 3 parameters that can be set, with the values in the table below.

| Parameter |  |  |  |
|-----------|---|---|---|
| Default   | 01:00   | 60°C  | 20%   |
| min-max   | 1 min - 12 hours  | 60°C - 150°C  | 0% - 100%   |
| step      | 1 minute for the minutes<br>1 hour for the hours                                  | 1°C   | 1%  |

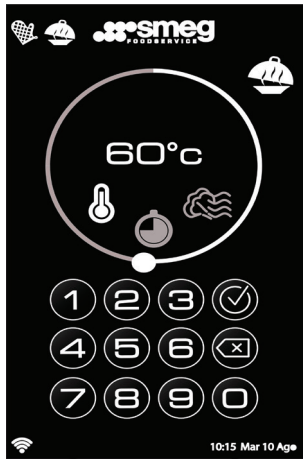
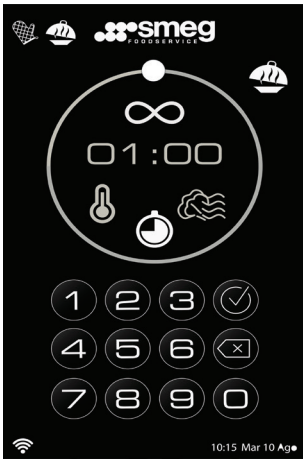

The hold icon will already be yellow because it is activated by the default values. When you access this function, the time screen is the first one displayed; pressing the required parameter changes the settings screen and the relative icon inside the circle becomes white. This way of entering settings is the same for all parameters. Use the hold button to activate / deactivate the hold function:

Reactivating the hold function restores the values that were present before it was deactivated.

The confirm button takes you back to the previous screen.

ZE



# Use

## PREHEAT IN PROGRESS SCREEN



It precedes all the cooking steps that were entered.

The target temperature (the one to be reached) is on the right side. The oven temperature is on the left.

The dots of the steps shown in grey indicate the steps still have to be carried out. The red dots under the time scroll across the screen to indicate that the cycle is in progress.

Pressing the Skip button  takes you to the next step.

## STEP IN PROGRESS SCREEN



The total time is indicated at the top of the screen (for example 02:00 in the figure). The red dots under the time scroll across the screen to indicate that the cycle is in progress.

The numbers indicate the steps of the recipe, the step number in red is the one summarized on the display. The steps in grey are the available steps and the semi-transparent ones are steps that have already been completed.

The central part of the display indicates the essential parameters of the step (time, temperature, core probe,  $\Delta T$ ) and the following, which appear slightly smaller:

- exhaust opening
- ventilation mode and speed.

They can be modified by selecting the  icon or by adjusting each individual parameter.





Selecting the bottom left icon during the CYCLE IN PROGRESS, STEP IN PROGRESS and HOLD screens brings up a summary of the cooking steps and allows you to modify the preset parameters.

## COOKING END SCREEN

The following operations can be carried out from the end of cycle screen:

- save the cooking cycle (📄);
- repeat the cycle that has just ended (🔄);
- change the parameters of each step by touching the relative icon (in this case time, temperature, exhaust, speed);

## HOLD IN PROG SCREEN



The hold phase (if set) starts at the end of the cooking cycle.

Pressing the Skip button (⏭) ends the hold cycle. The light inside the oven switches on/off intermittently at the end of the cycle to indicate that the function has ended.

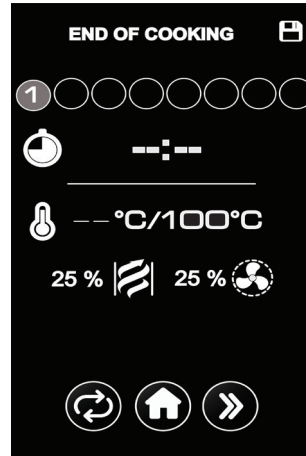





## Use

### MY RECIPES SCREEN

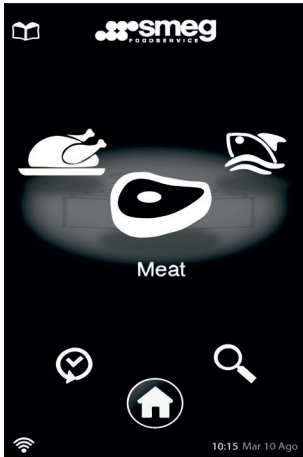
The MY RECIPES menu groups all the recipes created by the user and is indicated by the  icon at the top left.



### SMART COOKING SCREEN

The SMART COOKING menu  groups all the recipes created by Smeg and which are available in the menu. If a recipe is modified, it can be saved in MY RECIPES.

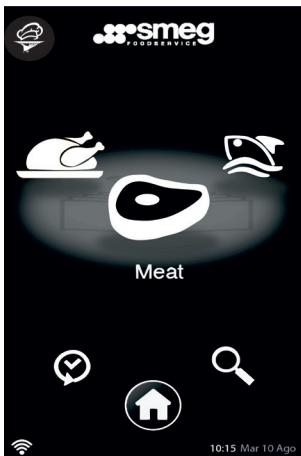

For both menus, you can use the scroll to select the category of dishes and also choose the type of cooking.

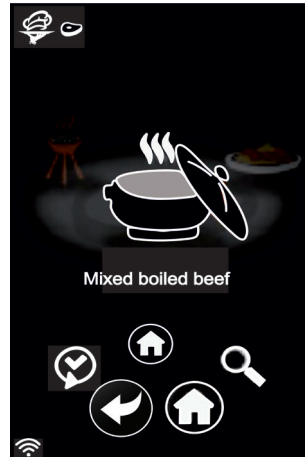

To delete a recipe, press the flashing bin icon, then press and hold the name of the recipe to be deleted.



Choosing a recipe from the “MY RECIPES” screen will display the STEP SUMMARY page of the recipe, in which the steps can be modified.



Once the step has been modified; it can be saved using the  icon at the top right.



It is now possible to start the cooking cycle using the start button , regardless of whether the recipe has been saved or not. CHANGES WILL BE LOST IF YOU EXIT WITHOUT SAVING.



## Use

### COOKING MODES

- **CONVECTION:**

The combined action of ventilation and the heating elements allows food to be cooked.

The circulation of hot air in the oven chamber ensures an instant and even distribution of heat.

- **CONVECTION + STEAM:**

Using convection cooking, combined with steam, food can be cooked using the combined-mixed steam cooking function (a hot environment created by convection combined with a variable amount of steam and controllable via the display, interface and oven controls).

- **STEAM:**

It is possible to cook in 100% steam mode using the Smeg patented steam generation system.

This preserves the taste and aromas of the food without removing any liquids that are naturally contained in the dishes.

### 3.3 SETTING MULTI-COOKING

Pressing the  icon on the main screen accesses the multi-cooking environment showing the "ONE SHOT"  and "ALL IN TIME" options .



Select the  icon to start the one shot or all in time cooking mode.

The  symbol indicates the saved environment with the relative cooking parameters.

In both cooking modes, the essential parameters (temperature, fan speed, steam, exhaust) are set, assigning different cooking times for each tray.



## ONE SHOT

Once one shot mode has been enabled using the methods available, all the cooking parameters can be set except the time.

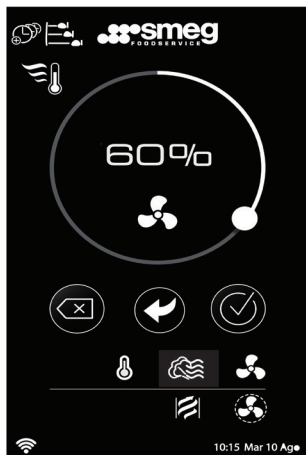

The confirm button  activates the screen that shows all the cooking levels (trays) available.



To assign a cooking time, press “+”.

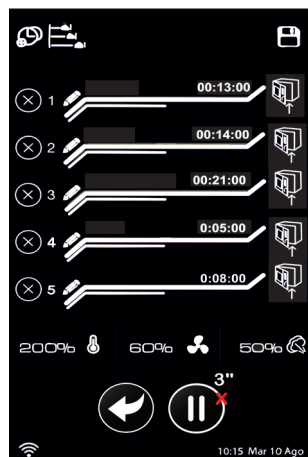

You can also assign a name to each level by pressing .

Press “x” to cancel and/or re-enter the settings.



Start the cooking cycle using the start icon



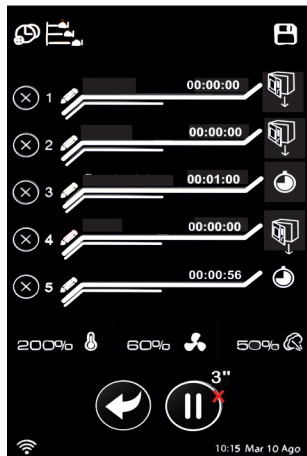

The insert tray icon , appears on the display for each level (light blue), associated with a beep and a flashing light.

The level of the tray that will finish cooking first turns yellow, the others are red.



A beep is emitted and the  symbol appears to indicate that cooking on the associated level has ended. Selecting the  button takes you back to the previous screen so that you can modify the cooking cavity parameters.

All levels on the display remain available for additional changes to be made.

You can now choose whether to save the previously set environment by pressing  (it is saved in one shot-my recipes ); or restart another cooking cycle by pressing the  button.

If you select the pause icon for more than two seconds, it takes you back to the initial menu screen.

## ALL IN TIME

Once all in time mode has been enabled using the methods available, all the cooking parameters can be set except the time.

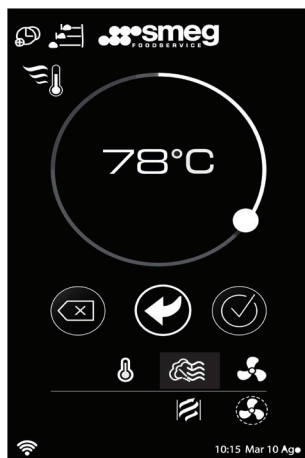

The confirm button  activates the screen that shows all the cooking levels (trays) available.

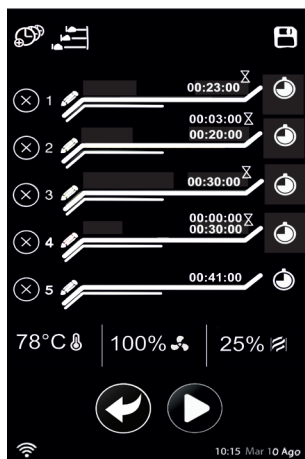

# Use



To assign a cooking time, press "+".

You can also assign a name to each level by pressing .

Press "x" to cancel and/or re-enter the settings.

Start the cooking cycle using the start icon .

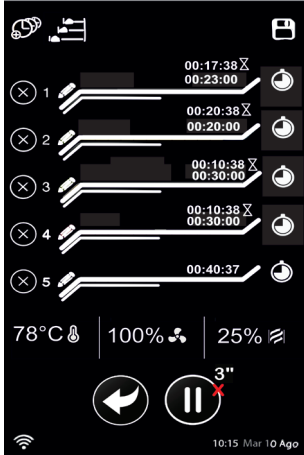

The above screen shows an example of an all in time cooking mode at full load.



With multi-cooking (all in time), it is possible to have all the trays ready at the same time.

The insert tray icon  appears on the display for each level, associated with a beep and a flashing light. The level that will take the longest (red) flashes until the corresponding first tray is inserted.

Once this step has been completed, the timer will start.

In the following stage, the next tray that has to be inserted, in order of time, turns yellow.

Once cooking has been completed for all levels, the  icon appears indicating that the trays should be removed.

When the program has finished, COOKING END appears. You can now choose whether to save the previously set environment by pressing  (it is saved in all in time-my recipes ); or restart another cooking cycle by pressing the  button.

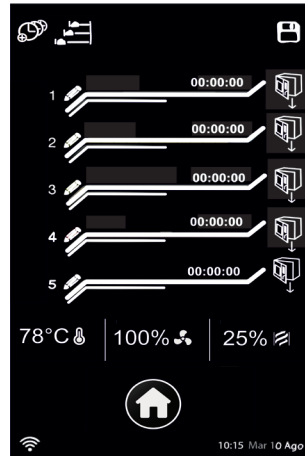

Z  
U



## Cleaning and maintenance

### 4. CLEANING AND MAINTENANCE

#### 4.1 AUTOMATIC WASHING FUNCTION

On the HOME PAGE screen, press the  icon. The following screen appears in which you can select a wash cycle, monitor the level of detergent and start emptying the reservoir.



Touching the selected washing mode, the relative time is displayed when start is pressed.

Once washing has started, a message appears showing the remaining washing time (countdown).



#### CAUTION:

**DO NOT OPEN THE DOOR DURING WASHING TO AVOID ACCIDENTALLY COMING INTO CONTACT WITH THE DETERGENT MIXTURE.**

You can pause the cycle by pressing the , or if you wish to stop the cycle, you should press the  icon.



If a wash cycle is stopped automatically, the oven carries out a rinse cycle. It is possible to return to the initial screen and start a new function only after the rinse cycle has been completed.

If the oven is still too hot ( $>70^{\circ}\text{C}$ ) when you decide to start a wash or rinse cycle, the selected program will not start; a warning will appear (see image below) and a cooling process starts.

Washing will start after the cooling cycle has ended.



**TOO HIGH  
TEMPERATURE**

COOLING IN PROGRESS







Do not place accessories, trays or other objects in the oven during the wash cycle. It is also recommended to let the oven cool down before starting the wash cycle. Always use products recommended by the manufacturer.  
<https://www.smegfoodservice.com/>

## 4.2 EMPTYING RESERVOIR

It is recommended that you empty the reservoir if the appliance is not going to be used for some time. It is also necessary to do so if maintenance has to be carried out that requires the reservoir and the washing circuit to be empty.

Use appropriate PPE as indicated in the messages on the display.

Press the  icon to start emptying. The display will indicate the actions required step-by-step to restore the functionality of the appliance until the process is completed, which ends with a final rinse (indicated by the relative progress bar).

Emptying can be stopped manually by pressing the "X" under the  icon but the final rinse will still be carried out.

**NOTE:** Once emptying has started, all appliance functions are inhibited until the final rinse has been completed.

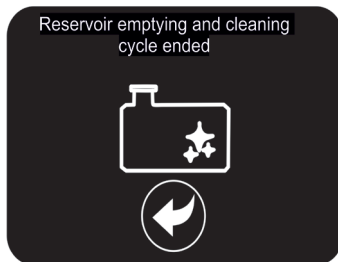
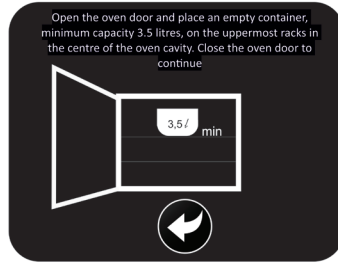



## Cleaning and maintenance

### REGULAR MAINTENANCE

- The appliance should be inspected at least once a year by a qualified and trained technician.
- All maintenance work must only be performed by a qualified technician.
- Before performing any kind of maintenance, unplug the appliance from the mains and wait for it to cool down if it has recently been used.

### 4.3 WASHING DETERGENT RESERVOIR

The level of detergent in the reservoir is displayed by the “detergent level” bar which changes from green (reservoir full), to yellow (about half full), to red (nearly empty) to flashing red (to be topped up).

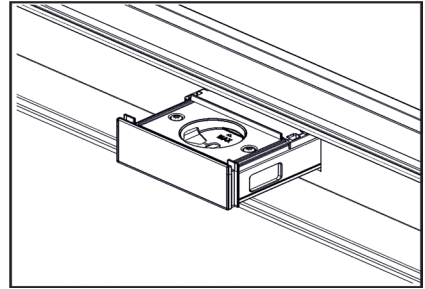

The level of detergent can be seen in the window at the side of the reservoir. If the detergent has to be topped up, proceed as follows:

1. Open the detergent reservoir.
2. Partially withdraw the drip tray at the base of the oven to collect any detergent spills.
3. Pour the detergent liquid into the reservoir up to the maximum level (maximum capacity 3 litres).
4. Put back the reservoir and the drip tray under the oven.



## 4.3.1 EXTERNAL DETERGENT SUPPLY

Alternatively, you can use the external detergent filling kit (on some models and/or configurations), which involves inserting special external suction lances directly into the container.



**ALWAYS USE SAFETY EQUIPMENT (GLOVES, GOGGLES... ETC.), WHEN ADDING DETERGENT. DO NOT TOUCH THE DETERGENT WITH BARE HANDS.**

The kit must only be installed by trained and qualified personnel by manufacturer.

## 4.4 FILLING THE RESERVOIR USING A CONTAINER OF DETERGENT

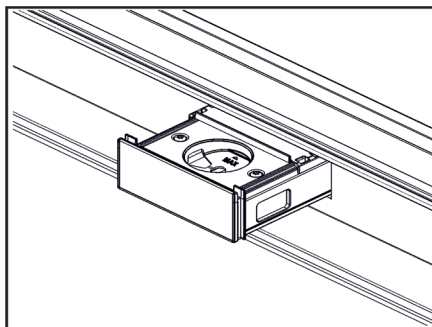

For safety reasons, and to avoid hazards when pouring the detergent into the reservoir, it is recommended that you use small 1-litre containers, or that you transfer the liquid from the large container into a smaller container before pouring the detergent into the reservoir.



**CAUTION: USING AN UNAPPROVED DETERGENT COULD DAMAGE THE WASHING SYSTEM AND AFFECT THE INTEGRITY OF THE OVEN CHAMBER, THEREBY INVALIDATING THE MANUFACTURER'S WARRANTY. WE THEREFORE RECOMMEND THAT YOU CLEAN THE OVEN USING A SMEG-APPROVED OVEN CLEANER THAT CAN BE PURCHASED FROM OUR DEALERS.**



## Cleaning and maintenance

### 4.5 CLEANING THE APPLIANCE



We suggest that you use cleaning products recommended by the manufacturer. See <https://www.smegfoodservice.com/>

Recommendations for cleaning the appliance.

To keep the surfaces in good condition, they should be cleaned regularly after each use.

Every 10 operating hours, a message appears on the display:

“AFTER USE, WE RECOMMEND THAT YOU CARRY OUT A WASH CYCLE”.

Carry out the wash cycle, after which, the message disappears and the time counter is reset.

### ORDINARY DAILY CLEANING

Always and only use specific products that do not contain abrasives and/or chlorine-based acids. Always check the product label.

Pour the product onto a damp cloth and wipe the surface (at room temperature) rinse thoroughly and dry with a soft cloth or a microfibre cloth.

Do not use steel sponges or sharp scrapers to remove food stains or residues, as they will damage the surface.

Use non-abrasive products.

Rinse the surface thoroughly and dry with a soft cloth or a microfibre cloth.

### 4.5.1 CLEANING THE DOOR

The glass of the door should always be kept thoroughly clean. In case of stubborn dirt, wash with a damp sponge.

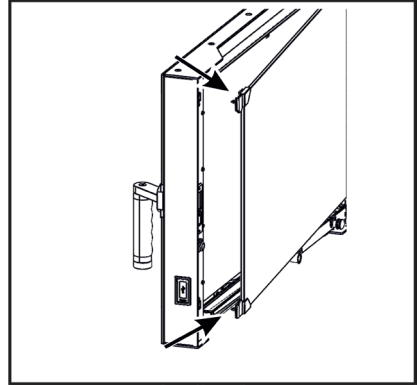

#### CAUTION:

**BE VERY CAREFUL WHEN REMOVING THE TRAYS FROM THE OVEN BEFORE STARTING A WASH CYCLE. ALWAYS WAIT UNTIL THE SURFACES COOL DOWN TO ROOM TEMPERATURE. ALWAYS WEAR HEAT RESISTANT CLOTHING (GLOVES ETC.).**



## 4.5.2 CLEANING THE DOOR DRIP TRAY

It is recommended that you release the glass carefully when inspecting and cleaning the drip tray.

1. Push the drip tray upwards to release it.
2. Remove the drip tray; be careful of any liquids contained in it.
3. Empty the drip tray and clean it.
4. Replace the drip tray, aligning the slots on it with the screws on the door and moving it downwards.

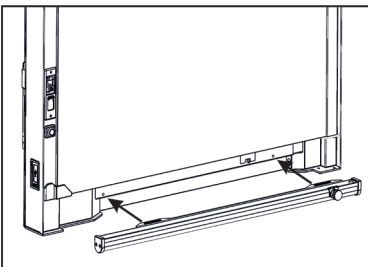
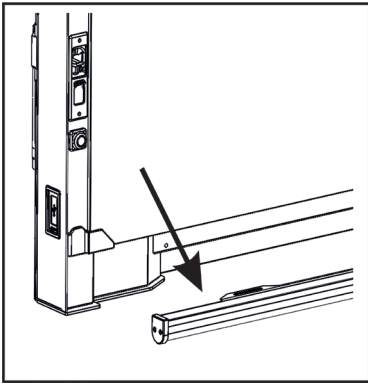

## 4.5.3 CLEANING THE REMOVABLE DRIP TRAY AT THE BOTTOM OF THE OVEN

1. The drip tray slides out like a drawer.
2. Remove the drip tray; be careful of any liquids contained in it.
3. Empty the drip tray and clean it.
4. Put the drip tray back, inserting it correctly in its seats.

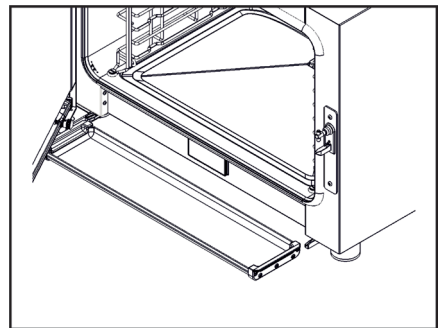
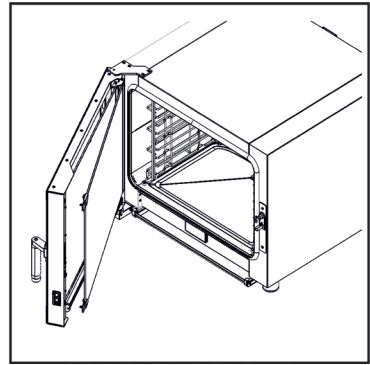



## Cleaning and maintenance

### 4.6 CLEANING THE OVEN CAVITY

#### CLEANING THE OVEN CAVITY

Clean your oven regularly in order to keep it in the best possible condition. Under no circumstances spray cold water into the oven cavity if it is still hot to prevent damaging it. Avoid letting food residues dry inside the oven cavity, as this could damage the surfaces.

#### REMOVING THE TRAY SUPPORT FRAMES

Removing the tray support frames enables the sides of the oven to be cleaned more easily.

1. Loosen the fastening ring nuts at the front

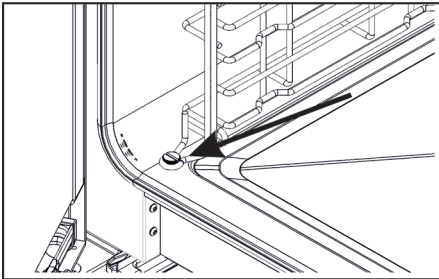

2. Remove the frames by pulling them outwards from the oven chamber.
3. After cleaning, put the tray support frames back in the oven and fasten them with the fastening ring nuts.

### 4.7 EXTRAORDINARY MAINTENANCE

The seal should be removed to make cleaning easier.

#### TO REMOVE THE SEAL:

- Starting from the joint at the centre, pull the seal outwards to remove it (see photo) following the side profile of the oven opening.

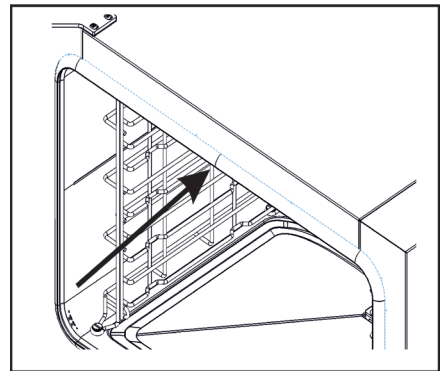
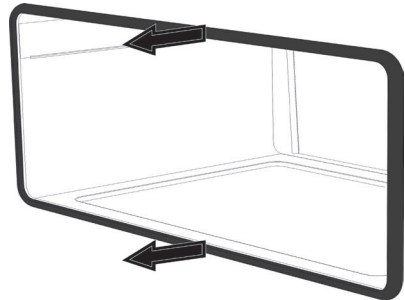



When you have finished using the oven, remove any large food residues and clean the seal using a non-abrasive sponge or a damp cloth.

The seal should be soft, flexible and undamaged.

## TO REPLACE THE SEAL:

Position the seal in the upper groove and then press it carefully down until it adheres to the front of the appliance.

The joint of the seal must be positioned at the top as shown in the photo.

## REPLACING THE INTERNAL LIGHT BULB

This operation must be carried out by a qualified technician.

The led strip is located in the door.



Live parts  
Danger of electrocution  
• Unplug the appliance.



The oven cavity is fitted with a 9 W LED strip.



To prevent safety hazards for users, all technical inspections or repairs must be carried out by qualified personnel.

## SAFETY THERMOSTAT

The appliance is equipped with a safety device that triggers in case of serious malfunction.

Only for the installer/technical support:

1. Unscrew the protective cover for the thermostat.
2. To reset the safety thermostat, press the button on the back.

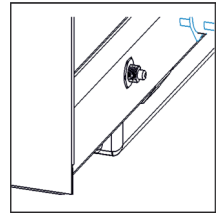
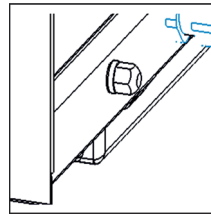

In the event of a fault, contact the Technical Assistance service.



# Settings

## 5 SETTINGS MENU

Selecting the  icon allows you to set and customize the oven parameters.

The  icon allows you to select the language, which is done by sliding the language icon to the right or left.

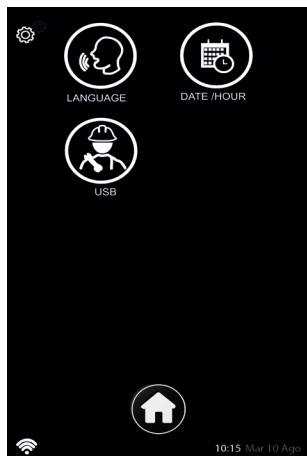





## 5.1 SETTING THE DATE / TIME

Selecting the  icon allows you to choose the time format, 24 hours or 12 hours AM/PM.

The setting becomes yellow, the other remains grey.

Touching the hours or minutes allows the corresponding value to be adjusted using the scroll or keypad.

The setting that is adjusted becomes yellow, the other remains white.

The date is set by scrolling to the day, month, year.

Once the settings have been completed, confirm using the  button.

Touching  will discard the changes.

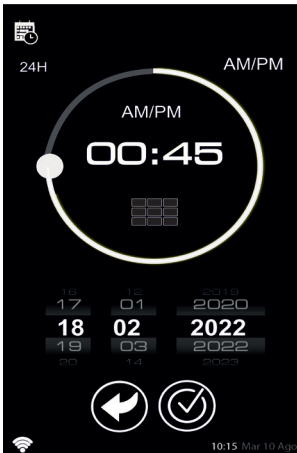



# Installation

## 6 INSTALLATION

### 6.1 ELECTRICAL CONNECTION



The terminal indicated by this symbol  connects components together that are normally earthed. Connect the appliances appropriately using this terminal in order to make sure that they are equipotential.



If the phase voltage drops below 190V~, the performance of the oven may suffer, not due to the product itself.

### GENERAL INFORMATION

Make sure that the characteristics of the mains power supply are compatible with the data indicated on the plate. The identification plate bearing the technical data, serial number and brand name is placed in a visible position on the appliance. Do not remove this plate for any reason.

Perform the ground connection using a wire that is 20 mm longer than the other wires.

The appliance is provided with a five-core H07RN-F cable (5 x 2.5 mm<sup>2</sup> referring to the cross section of the internal conductor).

### 6.2 CONNECTING TO THE MAINS POWER SUPPLY

- The appliance should only be connected to the mains power supply by a qualified technician and in compliance with current plant safety regulations.
- Before connecting to the mains power supply, make sure that:
  - the supply voltage and frequency correspond to those indicated on the identification plate
  - the electrical system is suitable for the power required by the appliance and indicated on the identification plate on the oven
  - the electrical system is fitted with an earth connection in compliance with current regulations
  - there is a disconnect device between the appliance and the mains power supply with a minimum contact separation in overvoltage category III. The disconnect must be suitable for the electrical load of the appliance and comply with current regulations
  - the disconnect device is clearly indicated and easily accessible after the appliance is installed. Under no circumstances should the earth conductor (yellow/green conductor) be interrupted by the protection and isolation devices.
- The appliance must be connected to an equipotential system, the effectiveness of which must be ascertained according to current regulations. The equipotential bonding terminal is located at the back of the appliance.
- The appliance is fitted with a power cable connected to the internal terminal



board. If the power cable needs to be replaced, only use cables having the same electrical characteristics (type of insulation / number of conductors / cross section of conductors).

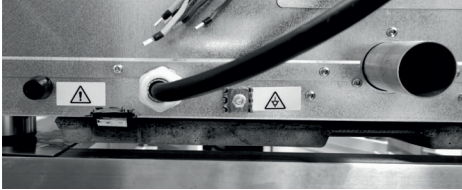

## CONNECTION MODES

- A diagram showing the permitted connection modes can be found on the back of the appliance next to the terminal board (see image below).
- 220-240 V 3~

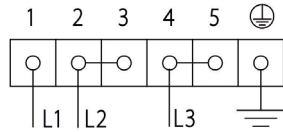

Four-core cable 4 x 6.0 mm<sup>2</sup>.

- 380-415 V 3N~

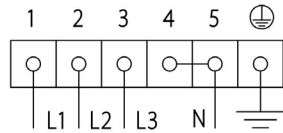

Five-core cable 5 x 2.5 mm<sup>2</sup>.

**i** The values indicated refer to the cross-section of the internal conductor.

Z  
E



# Installation

## FIXED CONNECTION

Fit the power line with an all-pole circuit breaker in compliance with installation regulations.

The circuit breaker should be located near the appliance and in an easily reachable position.

## CONNECTION WITH PLUG AND SOCKET

To connect:

220-240 V 3~

use a 4 x 6.0 mm<sup>2</sup> four-core cable

380-415 V 3N~

use a 5 x 2.5 mm<sup>2</sup> five-core cable

Check that the plug (not supplied) and power socket are compatible and of adequate capacity for the maximum current draw of the appliance.

Avoid using adapters and shunts as these could cause overheating and a risk of burns.

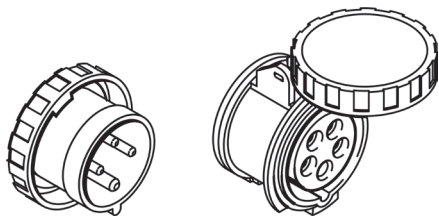

(Example of 32A plug and socket)

## CABLE REPLACEMENT AND TERMINAL BOARD CONNECTION



Power voltage  
Danger of electrocution

- Disconnect the mains power supply.
- The power cable should only be replaced by a suitably trained and qualified technician.

1. At the back of the appliance, unscrew the 2 screws to remove the metal cover of the terminal board.

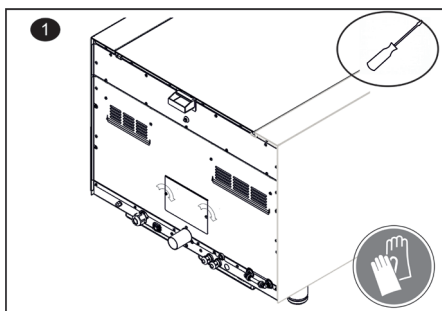

2. Use a screwdriver to release and lift the cover to access the terminal board.

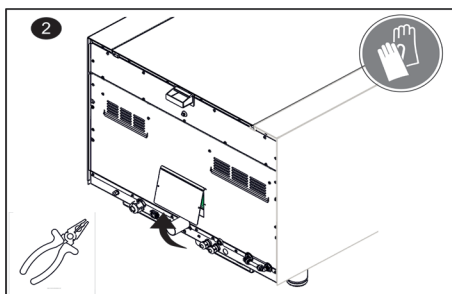



- Use pliers to remove the clamp, and modify the connection of the terminal board

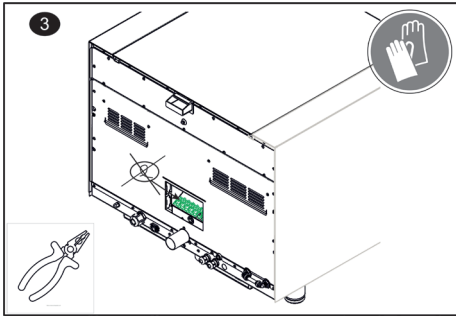

- Unscrew the cable gland, the panel screws and remove the cable.

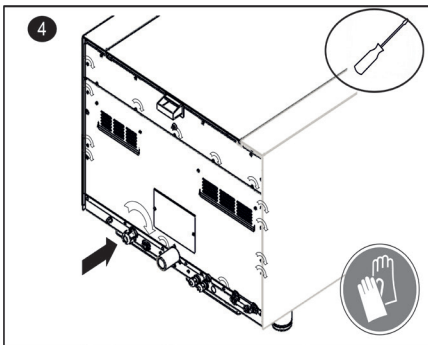

Replace the cable once all the steps have been completed. Make sure that the cables follow the best route in order to avoid any contact with the appliance.

## 6.3 CONNECTING TO THE WATER SUPPLY

- The water supply system must be compliant with current regulations.
- The appliance must be supplied with drinking water.
- The maximum inlet water temperature should not exceed 30°C.
- The amount of chloramine/chlorine dissolved in the water should be <0.1 ppm (mg/l).
- For the washing circuit:
  - The total hardness (TH) of the inlet water must be  $\leq 20^\circ \text{dH}$ .
- For the steam circuit:
  - The carbonate hardness of the inlet water must be  $\leq 4^\circ \text{dH}$ .
- Using untreated water encourages the formation of limescale inside the cooking chamber and significantly reduces the service life of some components.
- Do not connect the oven to a softened water supply system that uses salt. The presence of  $\text{Na}^+$  alters the water characteristics parameters.
- Damage caused by water values different to those indicated and failure to comply with the instructions herein are not covered by the warranty.
- There should be a shut-off valve between the water supply and the intake pipe of the appliance in order to turn off the water supply if necessary.
- Before connecting the appliance's water intake hose, run the water to eliminate any residues there may be in



## Installation

the water supply pipes.

- The appliance is fitted with a suitable "John Guest" hose (3/4 female fitting) with relative seal and mechanical filter on one side. On the other side, it is possible to connect the hose via an 8mm quick hose coupling.
- The appliance is connected to the water supply via the quick coupling at the bottom of the back of the appliance.
- Only use new hoses when connecting to the water supply. Old hoses should not be reused.
- The water supply pressure should be between 200 kPa - 1000 kPa (2 - 10 bar), the ideal pressure for correct washing is 3 bar. Lower pressures can affect both the washing and steam cooking results.

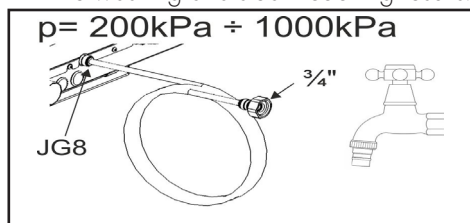

**SUPPLEMENTARY NOTE:** before connecting the product to the water supply, make sure that the water system has been fitted with a safety device to protect drinking water against contamination due to backflow (according to DIN EN 1717). The water valves and/or taps will already be fitted with these safety devices if the water system has been properly implemented.

### 6.4 CONNECTING TO THE DRAINAGE SYSTEM

- The connection to the waste water drainage system must be compliant with current regulations.
- The appliance should be connected to the waste water drainage system via the pipe at the lower back of the appliance. The pipe should be connected to high temperature resistant pipes (90°C-100°C) that have an external diameter of 40 mm (DN 40). Do not use metal pipes.
- The drainage pipes should be rigid and must not be pinched. The pipe must have a minimum slope of 4% – 5% along its entire length.
- The length of the pipes between the appliance and the discharge should not be longer than 2 metres. Limit the use of elbow joints (90°).
- A water trap (not supplied) should be provided between the appliance and the drain to prevent the return of vapours and odours. The water trap and drainage pipes should be checked and cleaned periodically (see figure below).
- If there are other appliances connected to the same drainage pipe, make sure it is large enough allow proper drainage and unobstructed flow.

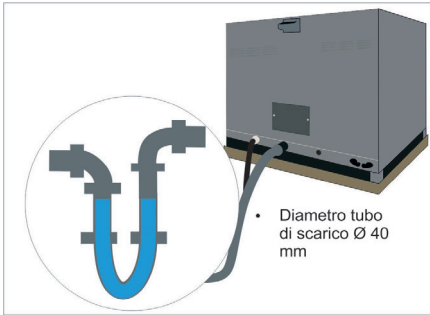

## WASTE WATER COOLING SYSTEM

Some models are fitted with a system for cooling the waste water, which allows significantly lower discharge temperatures to be obtained.

A cooling kit can be installed on site for models not fitted with this system.

To find out if this kit is compatible / available, refer to the official smegprofessional catalogue or visit the website [www.smeg-foodservice.com](http://www.smeg-foodservice.com).

The kit must only be installed by trained and qualified personnel by manufacturer.

To arrange for the kit to be installed, contact the Assistance Service or your dealer.

## 6.5 POSITIONING



### Heavy appliance

Crushing hazard

- Position the appliance with the assistance of one or more people according to current local regulations.



### Pressure on the open door

Risk of damage to the appliance

- Do not use the open door to lever the appliance into place when positioning it.
- Avoid exerting too much pressure on the oven door when open.



Heat production during appliance operation

Risk of fire and burns



### Improper installation

Risk of injury

- The work surface of the highest tray of the appliance should not exceed a height of 1.60 m from the floor.



# Installation

## STEAM OUTLET EXHAUST

There is an exhaust on the back of the appliance for discharging steam produced during cooking.

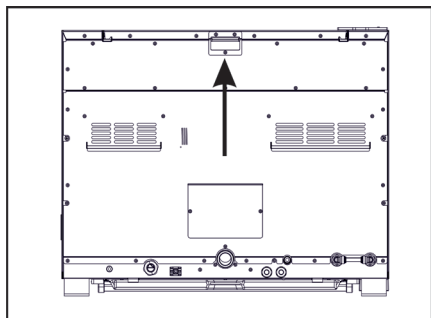

Make sure that it is not obstructed in any way. Make sure that it is not resting against or in contact with walls.

## MULTIPLE INSTALLATIONS



Weight: 95 kg

Place the appliance at a distance of at least 10 cm from any back wall and at 10 cm from any side wall. Keep a minimum distance of 10 cm between appliances if multiple appliances are installed alongside each other.



Do not install the appliance on the floor.

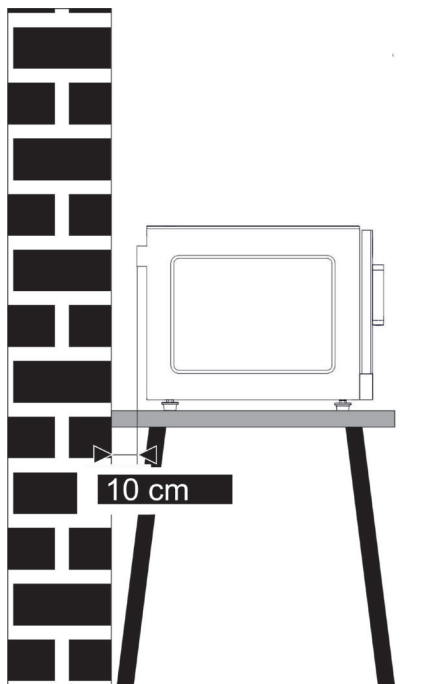
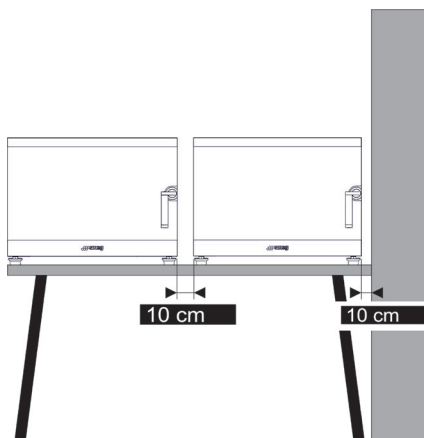

The appliance must be installed on a perfectly level worktop.





High food temperature  
Danger of burns

- For safety reasons, **DO NOT** position the uppermost tray at a height greater than 160 cm.
- If necessary, it is **MANDATORY** to apply the supplied adhesive label at the height indicated in the figure below.

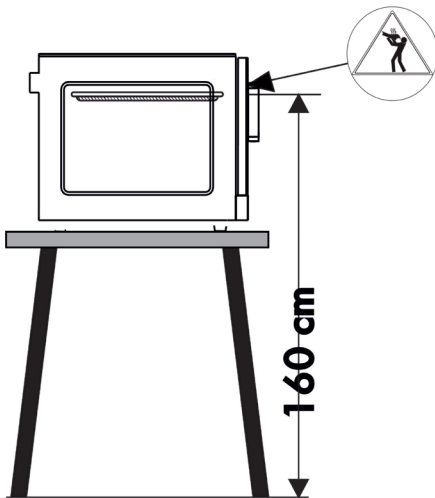

## POSITIONING THE OVEN

It is possible to level the oven, correct inclinations and position the appliance.

If necessary, the position of the feet can be adjusted by turning them manually clockwise or anticlockwise (see figure below).

For safety reasons, always use a spirit level or a digital level to check that the structure is perfectly level and stable.

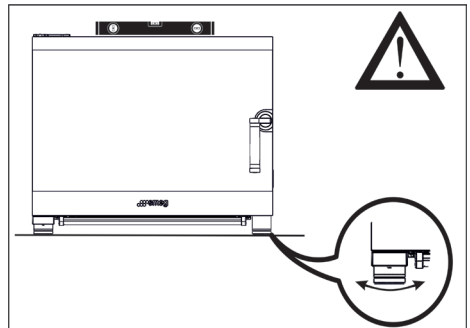



# Installation

## ADJUSTING THE DOOR

Once the oven has been positioned and levelled, adjust the door. To do this, use a Torx (T25) screwdriver to loosen the 4 screws of the upper hinge, align the door and then tighten the screws again.

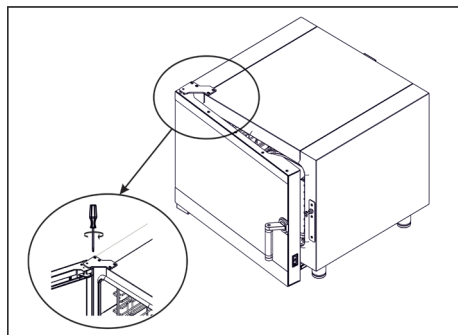

## NOTE FOR THE AUSTRALIAN MARKET



**Warning!**  
All installations must be completed by a qualified technician and must comply with all codes/standards including AS/NZS 3500.1.



## Error messages

Any error messages are shown on the display according to the table below. Only some faults prevent the oven from operating; others still allow it to be used, but you should always contact the Technical Assistance Service.

| <b>ERROR CODES</b> |   |
|--------------------|---|
| <b>ERROR CODE</b>  | <b>DESCRIPTION ON DISPLAY</b>   |
| <b>E01</b>         | Title = "COMMUNICATION ERROR"<br>Description = "CHECK POWER BOARD"                  |
| <b>E02</b>         | Title = "WRONG FW VERSION"<br>Description = "UPDATE POWER BOARD"                    |
| <b>E03</b>         | Title = "NO WATER PRESSURE"<br>Description = "CYCLE STOPPED"                        |
| <b>E04</b>         | Title = "TIMEOUT"<br>Description = "ERROR DURING COOLDOWN"                          |
| <b>E05</b>         | Title = "WASHES DATABASE"<br>Description = "UNABLE TO READ DATABASE, REINSTALL SW." |
| <b>E06</b>         | Title = "SAFETY THERMOSTAT"<br>Description = "OVEN OVER-TEMPERATURE"                |
| <b>E07</b>         | Title = "THERMAL CUTOUT"<br>Description = "MOTOR OVER-TEMPERATURE"                  |
| <b>E08</b>         | Title = "PROBE FAULT"<br>Description = "OVEN CHAMBER PROBE FAULTY"                  |

| <b>WARNING CODES</b> |   |
|----------------------|---|
| <b>WARNING CODE</b>  | <b>DESCRIPTION ON DISPLAY</b>                                 |
| <b>W01</b>           | Title = "WARNING"<br>Description = "LOW INLET WATER PRESSURE" |
| <b>W02</b>           | Title = "MOTOR RPM NOT DETECTED"                              |

# Faults



| FAULT  | POSSIBLE CAUSE                                    | POSSIBLE SOLUTION   |
|--|---|---|
| Water is dripping from the door.                     | Pinched / damaged seal.                           | Replace the seal.<br>Warning:<br>- Always clean the seal with a damp cloth afterwards.<br>- In the case of frequent use for grilled products (build-up of grease), also clean the gasket between production cycles. |
| Noises coming from the oven cavity during operation. | The tray holder frames are not secured correctly. | Secure the frames correctly, once the oven is cold.   |
| The lighting inside the oven does not work           | Defective light                                   | Contact a technician to replace the led strip   |
| The oven does not produce steam                      | No water supply                                   | Check the water tap   |
| Washing function does not work                       | No water supply                                   | Check the water tap   |
| The oven does not turn on                            | The main power switch is off                      | Turn on the main power switch   |
|  | The system fuse has tripped                       | Check the system fuses  |
| Steam escapes from the door                          | Door open.<br>Door micro switch faulty.           | Make sure the door is closed.<br>Contact Technical Assistance.  |
| Seal damaged   | Check seal  | Replace the seal.   |
| Nozzle clogged                                       | Encrustations in mechanism                        | Remove dried-on dirt.<br>Call technician.   |